



RokaCeram

PORCELAIN TILE CATALOGUE

www.rokaceram.ae / info@rokaceram.ae

ADORN YOUR DREAM...



DESIGNED & DEVELOPED BY ROKACERAM
www.rokaceram.ae / info@rokaceram.ae

INDEX

APANA	4
ISCO	12
ADALINA	18
LUCCA	22
LUNIER	28
MERLOT	34
ROSER	42
SKYLINE	46
TRAINA	50
VALERIA	54
CARRARA	58
CEMENT	62
LUMINA	66
MONTANA	70
PARDEN	74
SCABOS	80
GRIT	86
PATRICE	94
COPPER	98
GALASSIA	106
CHARM	112
MARBEL	116
PARMA	120

MONOCOLOUR	124
SUGAR COLLECTION.....	138
BARON	140
BAYER	144
CRUSH	154
FABIAN	158
MITTIC	162
SAIL	168
CARVING COLLECTION.....	172
TURIN	174
COCO	180
DENIZ	186
ARCHIPEL	192
MERIN	196
ROYAL	202
ARIZONA	210
DYAN	216
VIENA	222
KANTO	228
LENNA	232
BIRCOLA	238
WILLER	244

CERAMIC MANUFACTURING COMPANY

about us:

RokaCeram, a registered Spanish brand, manufactures and trades porcelain tiles. Offering a variety of sizes and finishings with the best and premium quality to meet your needs. Previously, RokaCeram's tiles were manufactured at Spain's neighboring factories.

Since 2013, we built our own factory to be able to produce better quality products at more competitive prices.

Located on a 200,000-square-meter plot of land, RokaCeram has been assigned the mission of producing 8,000,000 sqm of tiles and created 500 jobs.

The factory is fully equipped with **SACMI** machinery from Italy. The factory's expansion plans include installing third manufacturing line and expanding granule capacity by up to 20,000 square feet per day.

The cost-effectiveness and environmental friendliness of RokaCeram, as well as the optimal efficiency of our manufacturing lines and the production speed and excellent quality of our big tile and ceramic products, set us apart from our competitors.

We've also selected a wide choice of colors, glazes, and additives from **TORRECID**, a world-renowned Spanish manufacturer.

RokaCeram certified from ISO standards based on ISO 9001, ISO 14001, and ISO 45001 certificates from Europe.

OUR MISSION

Our mission is to exceed our customers' expectations by going above and beyond. We believe in enhancing our grasp of quality and providing exceptional service and also becoming a leader in bringing cutting-edge technology to market and serving our consumers with exceptional design and a compelling value proposition, fueled by constant advancements in tile creativity, innovation, efficiency, and customer service.

OUR VISION

We believe in the development of lifestyles and in being a globally innovative brand. We strive to set ourselves apart through the services and products we offer. We appreciate long-lasting values creation. We intend to increase our production capacity every year by boosting sales with our organized and scientific plans. We want RokaCeram to be a part of everyone's home.



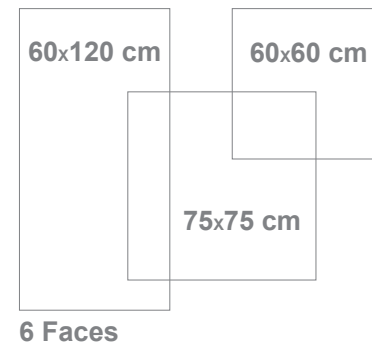

We clear the way for light, and interconnect the veins to each other tight; and light, as a crack, treks the tracks on the glass and enlightens the path; the darkness gives up so that the light and the hope rise up.



Thanks to its native 1.1cm thickness, provides lightness and strength in all applications - even the ones you'd never even imagined.



Rokaceram offers unmatched project flexibility and the freedom to give concrete form to your ideas without being shackled by size.





APANA BLACK



APANA BONE

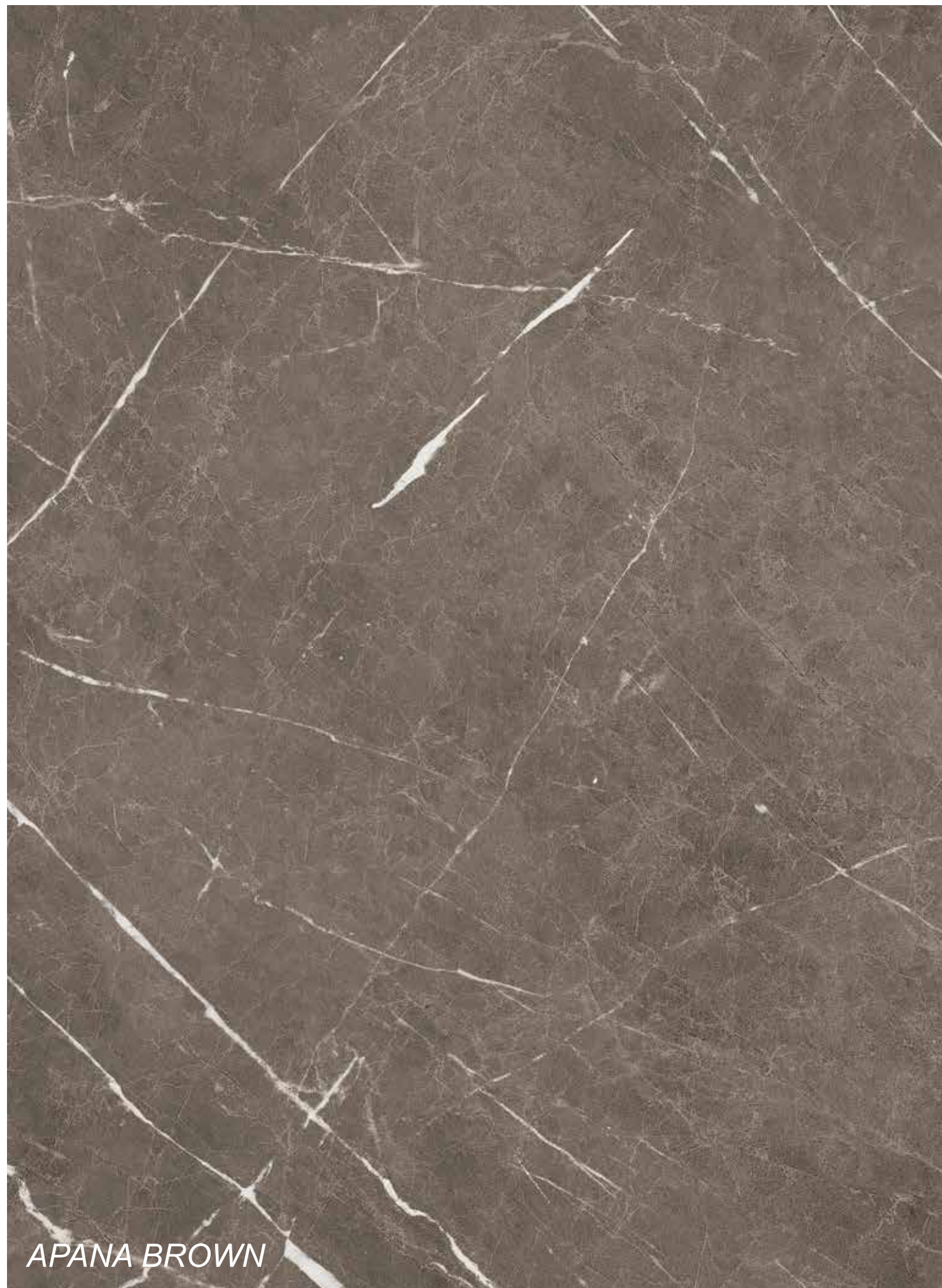

APANA BROWN



APANA DARK GRAY



APANA GRAY



APANA RED BROWN

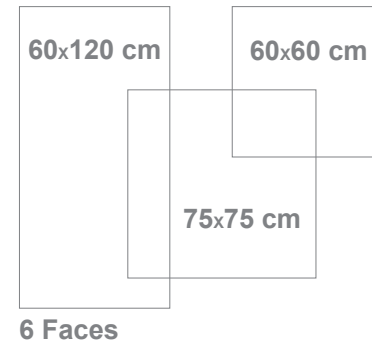

Intertwined strings, deep holes; and the thunder, which makes your mind wonder, be lost in imagination and ponder, in serenity, enjoying the spot by spot of the design. You leave there; yet, the traces of serenity eternally prevail with you immortally remaining the memories of walking in and experiencing the green and fresh alleys of imagination.



Thanks to its native 1.1cm thickness, provides lightness and strength in all applications - even the ones you'd never even imagined.



Rokaceram offers unmatched project flexibility and the freedom to give concrete form to your ideas without being shackled by size.

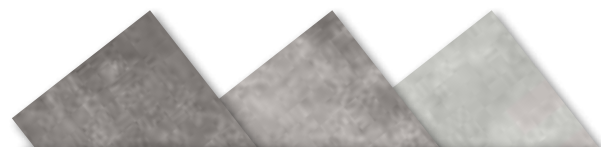



ISCO LIGHT GRIS



ISCO DARK GRIS



ISCO GRIS



**FEEL THE
INSPIRATION**

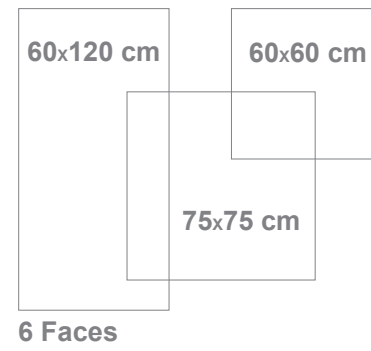

You ride the waves and journey into the dreams: a falling after a rise and a rising after a fall, touching the seconds and shedding light on your moments, offered to you as our souvenir.



Thanks to its native 1.1cm thickness, provides lightness and strength in all applications - even the ones you'd never even imagined.



Rokaceram offers unmatched project flexibility and the freedom to give concrete form to your ideas without being shackled by size.



RokaCeram



ADALINA



SPREAD
YOUR WINGS

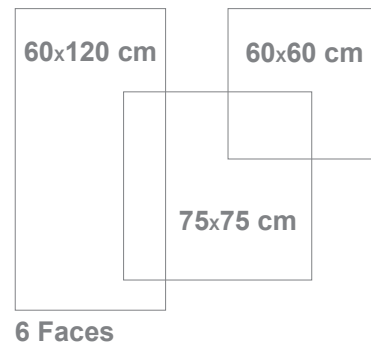

The dancing of the dots, the splash of colors. And the dots, either side by side, or at times far apart, this is the distance which defines the intensity. This is the concord and discord and whirling and twirling of the dots which exposes the design, leaving your eyes speechless by the grace and your mind numb in the dreams.



Thanks to its native 1.1cm thickness, provides lightness and strength in all applications - even the ones you'd never even imagined.



Rokaceram offers unmatched project flexibility and the freedom to give concrete form to your ideas without being shackled by size.

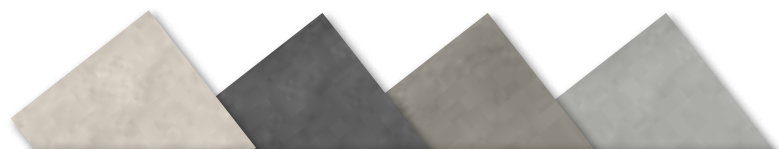

RokaCeram



LUCCA BONE



LUCCA DARK GRAY



LUCCA DUST



LUCCA LIGHT GRAY

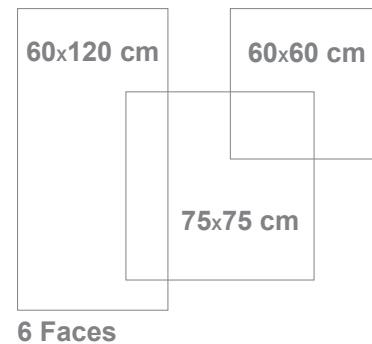

You'd touch the sky if and only if you hike by resolve and do not turn your eyes away from the top. You're here to pass the bumps and turn the rocks into the stairs, look into the brightness from the darkness and be tied to azure. Lunier is a design of such a life.



Thanks to its native 1.1cm thickness, provides lightness and strength in all applications - even the ones you'd never even imagined.



Rokaceram offers unmatched project flexibility and the freedom to give concrete form to your ideas without being shackled by size.

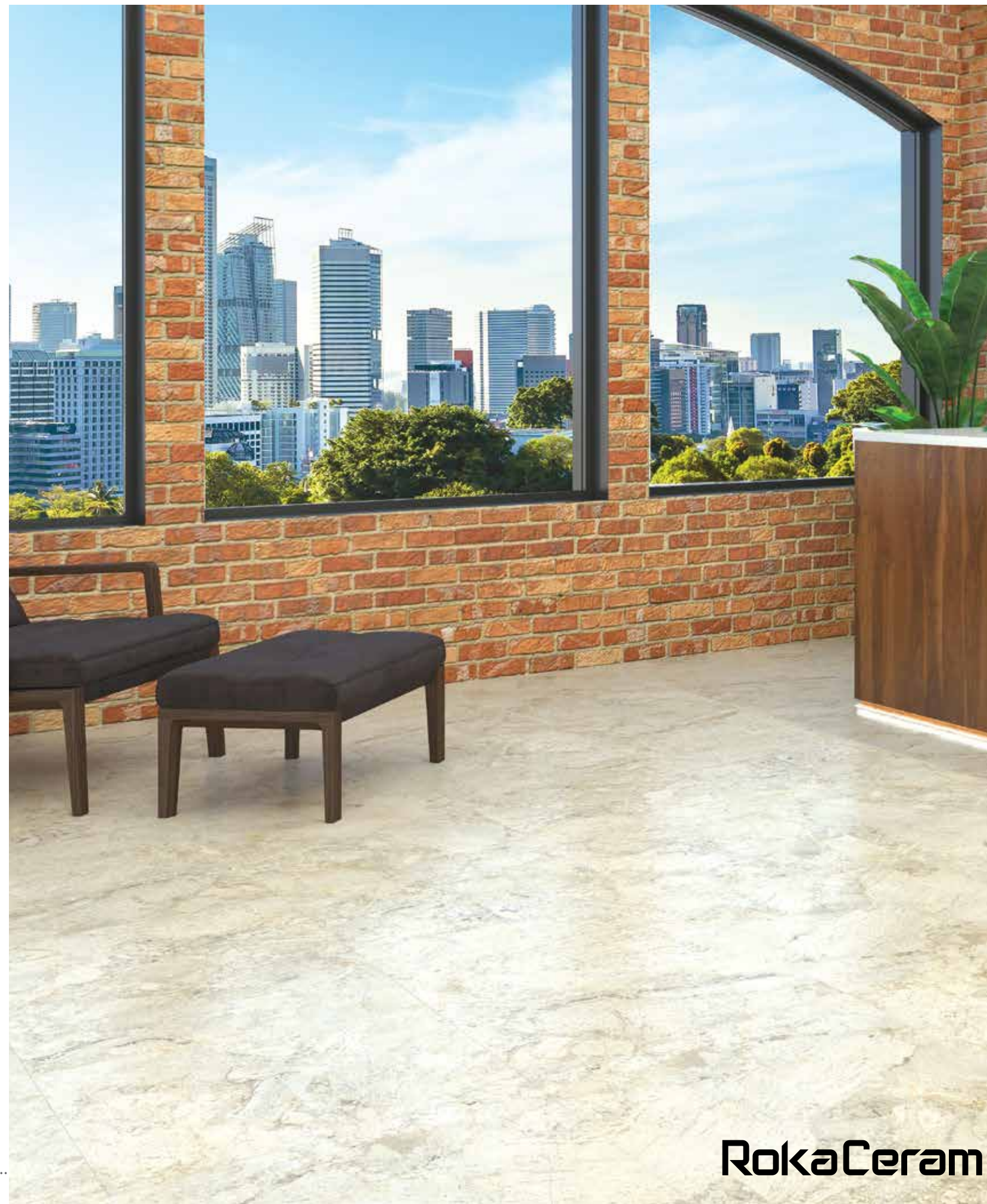

RokaCeram



LUNIER BEIGE



LUNIER GRAY



LUNIER LIGHT BONE

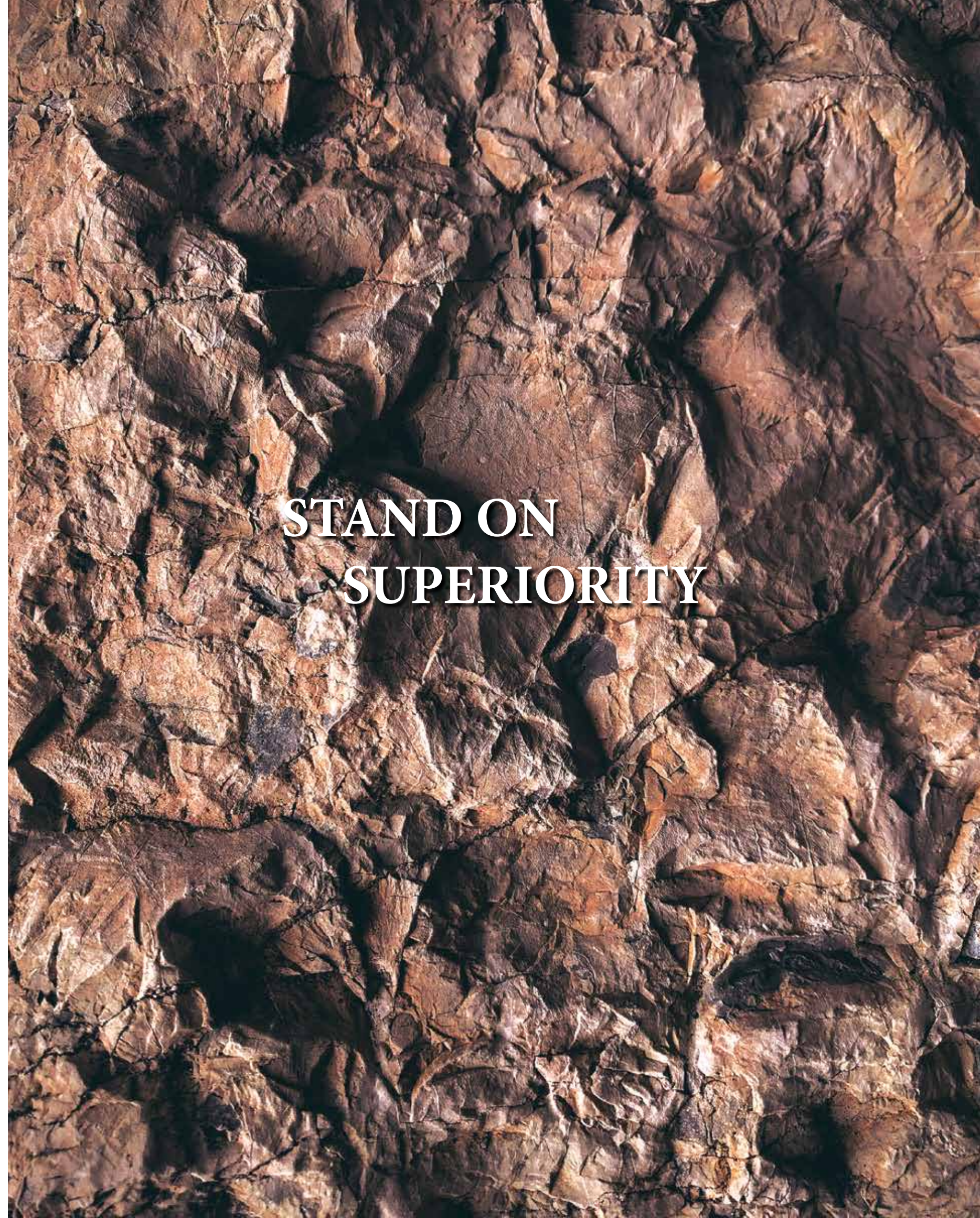

**STAND ON
SUPERIORITY**

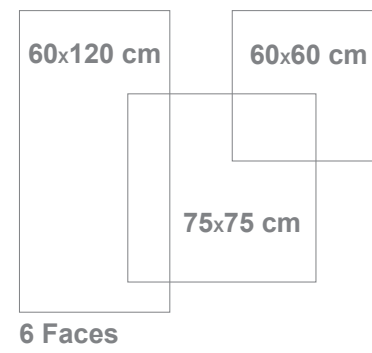

In the shadow of a wall, you sometimes need to stall to look. Looking into the depth of the moments and green of the life's seconds, breathing, wallowing and swallowing a bitter coffee. That bitterness of Merlot, will you find sweet.



Thanks to its native 1.1cm thickness, provides lightness and strength in all applications - even the ones you'd never even imagined.



Rokaceram offers unmatched project flexibility and the freedom to give concrete form to your ideas without being shackled by size.





MERLOT DARK CREAM



MERLOT DARK GRAY

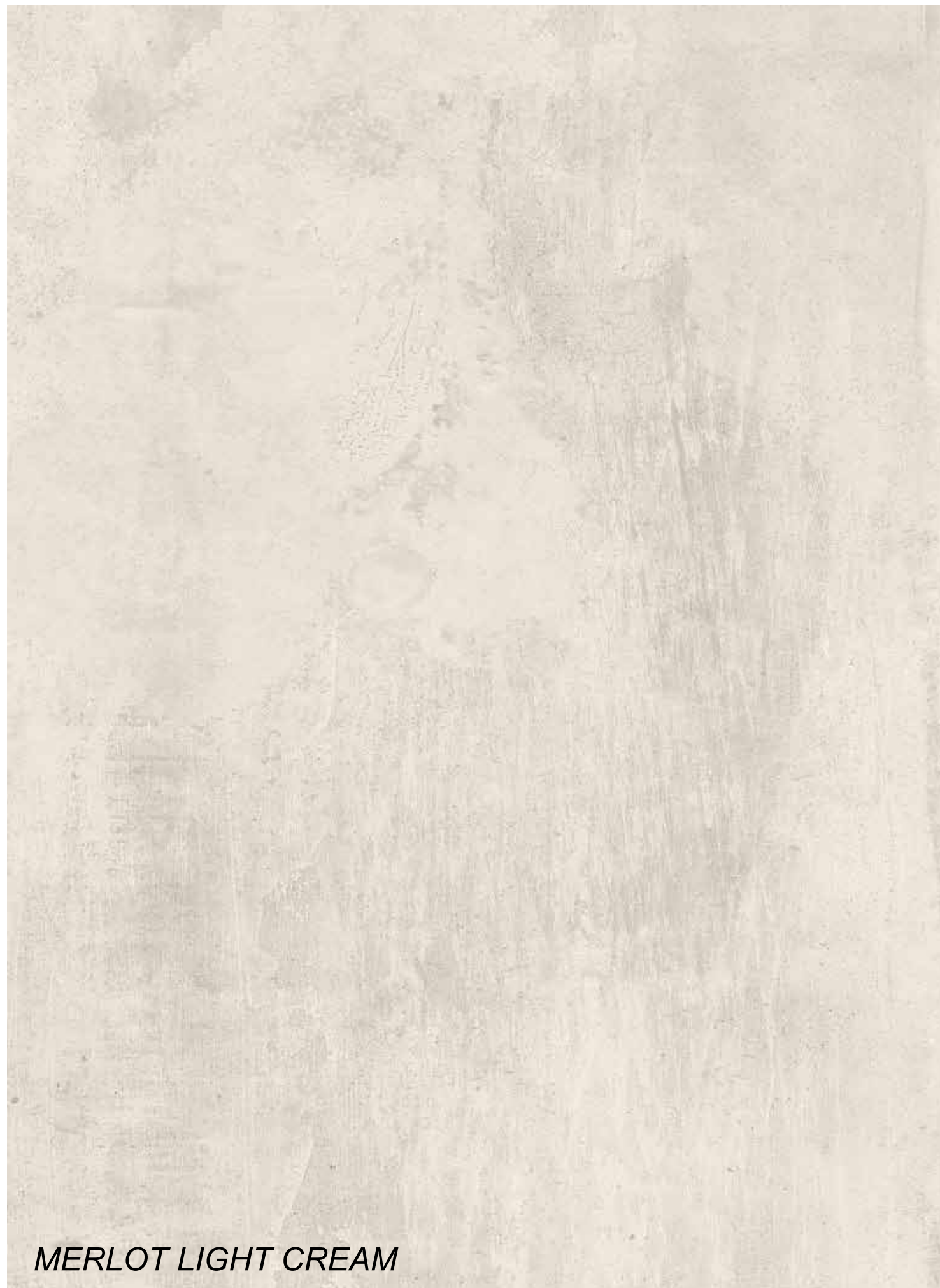

MERLOT LIGHT CREAM



MERLOT LIGHT GRAY

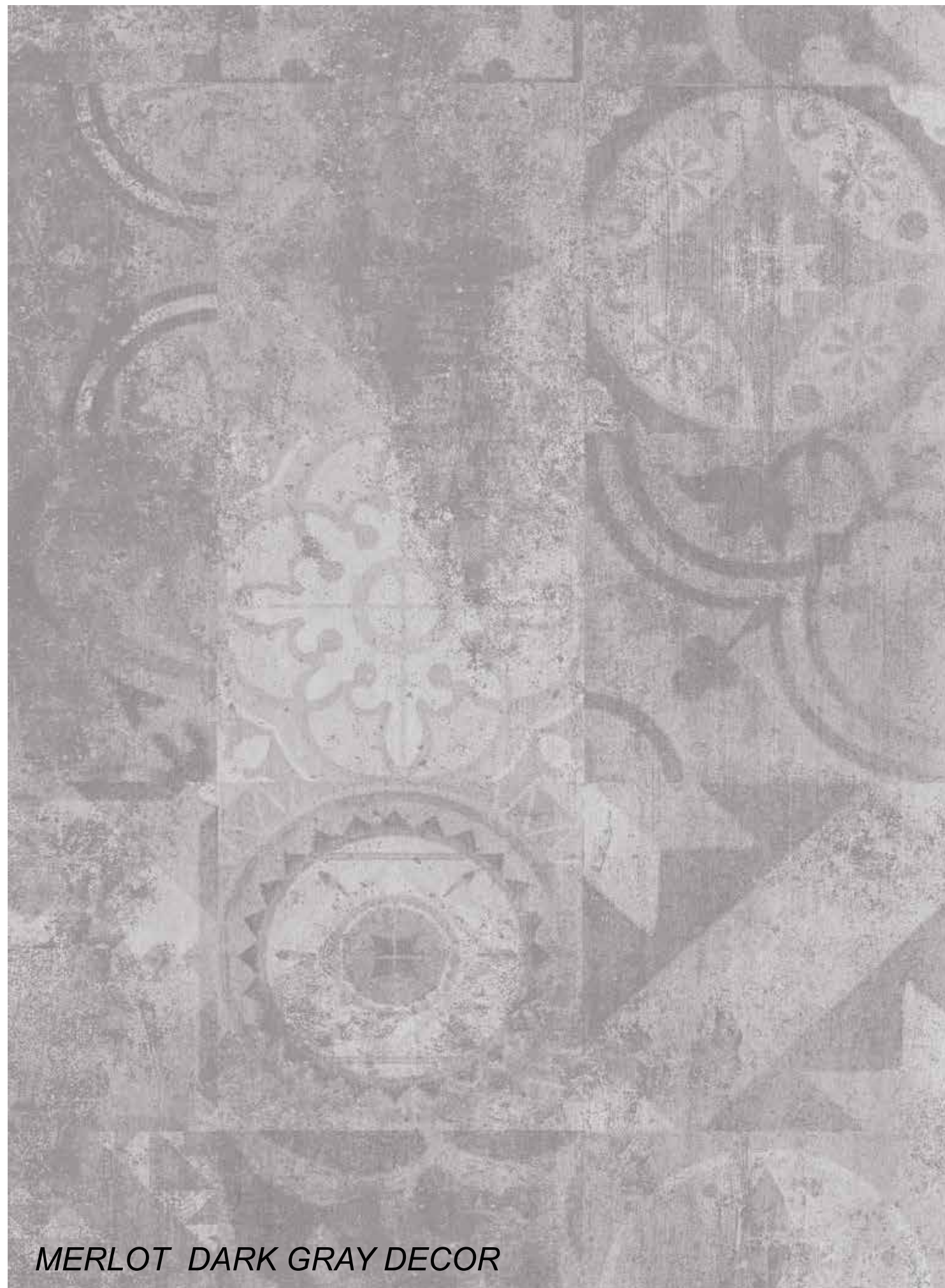

MERLOT DARK GRAY DECOR



MERLOT LIGHT GRAY DECOR

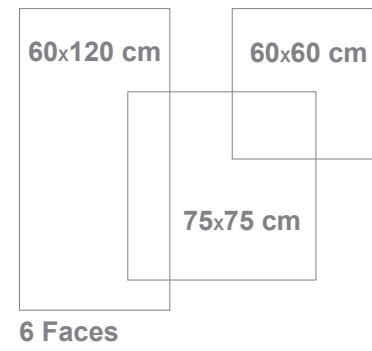

If the lines string along, blossoms will grow which are offered to your eyes, brightening your soul with the fragrance of life. Roser is a combination of such divergence, convergence and elegance.



Thanks to its native 1.1cm thickness, provides lightness and strength in all applications - even the ones you'd never even imagined.



Rokaceram offers unmatched project flexibility and the freedom to give concrete form to your ideas without being shackled by size.

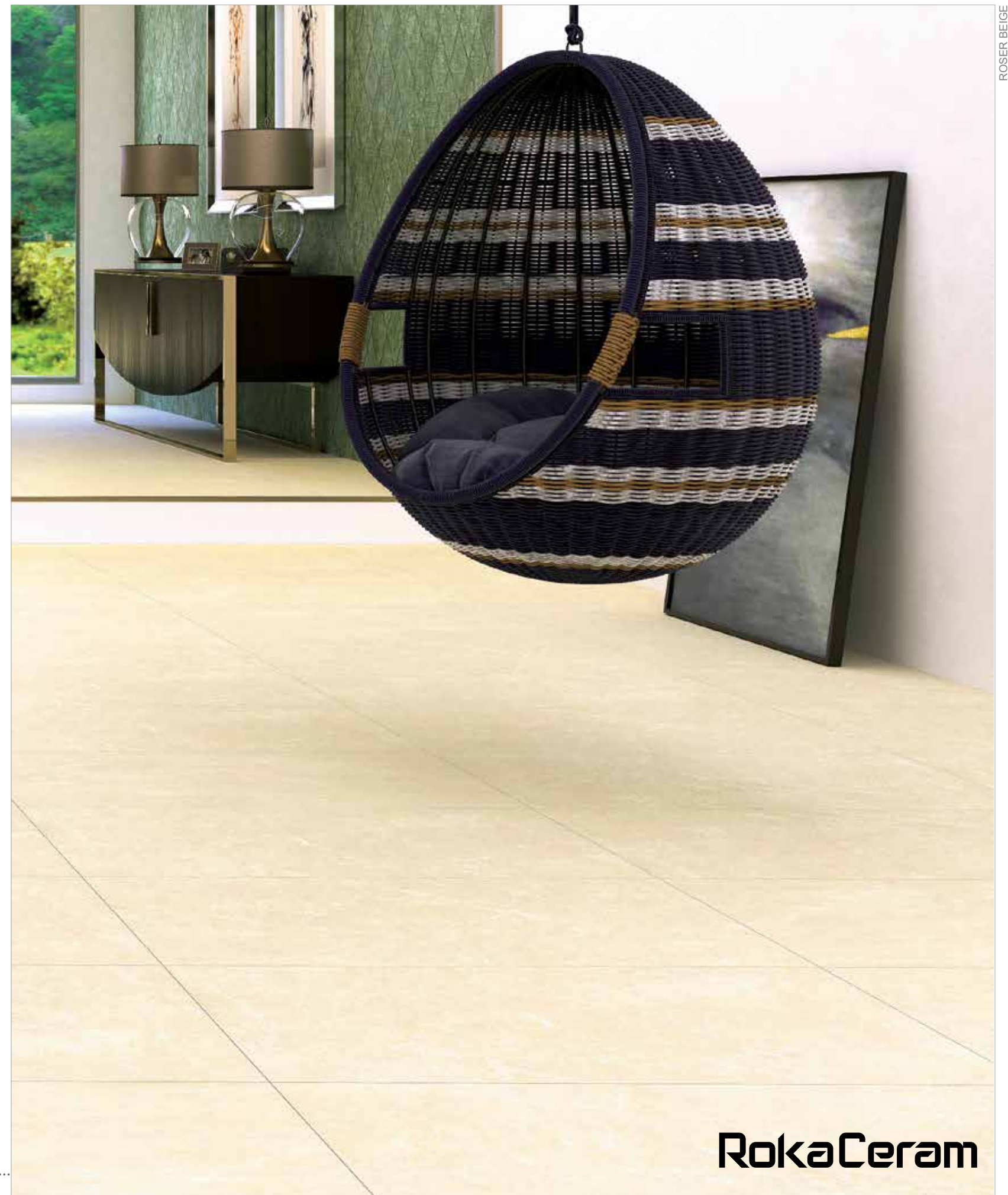
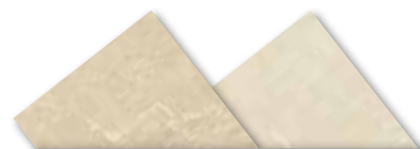

RokaCeram



ROSER BEIGE



ROSER BONE

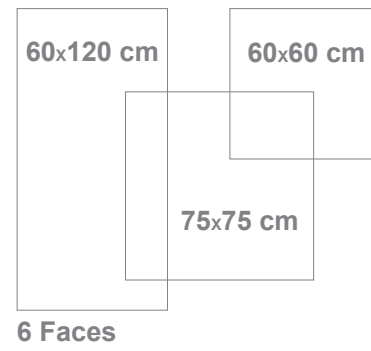

Life is nothing but the paths to walk on, a course of time and place, at times in the dark and at other times in the light. Skyline is a beautiful road to travel on, a cozy place to think in, and a good co-traveler to live with.

SPORT CENTER	HEADQUARTER	RESTAURANT	HOTEL	VENTILATED FACADES
HOME	SHOP	HOSPITAL	AIRPORT	OFFICE
FROST RESISTANCE	RESIDENTIAL USE	FLOOR TILES	LIGHT COMMERCIAL	WALL TILES



Thanks to its native 1.1cm thickness, provides lightness and strength in all applications - even the ones you'd never even imagined.



Rokaceram offers unmatched project flexibility and the freedom to give concrete form to your ideas without being shackled by size.



RokaCeram



SKYLINE PEARL

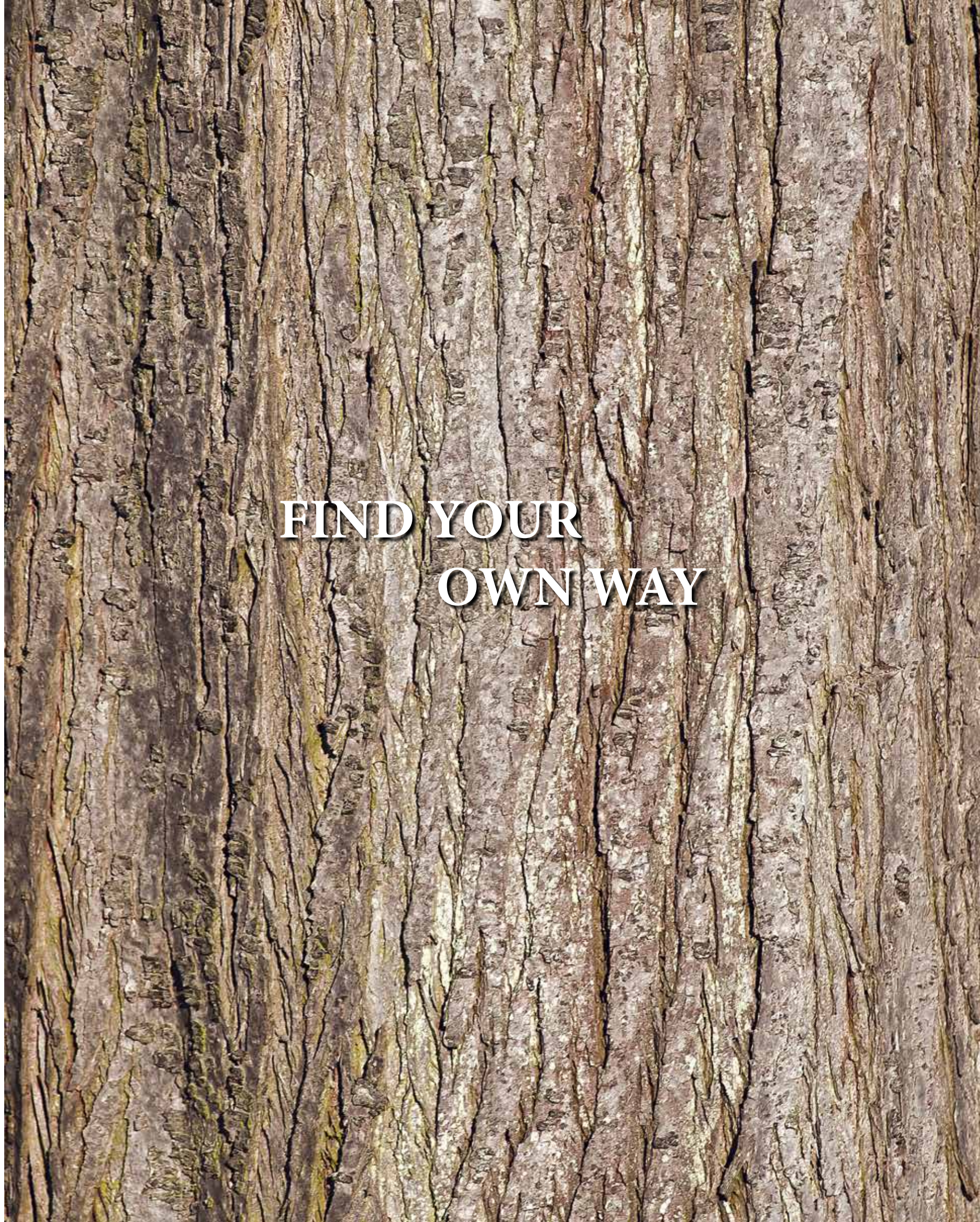

FIND YOUR
OWN WAY

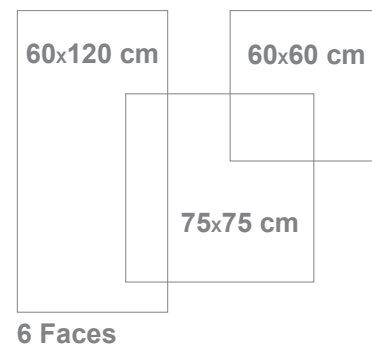

Pick up your footprints of the past and go for a fresh future. A future based on the rule of amity, beauty and serenity.



Thanks to its native 1.1cm thickness, provides lightness and strength in all applications - even the ones you'd never even imagined.



Rokaceram offers unmatched project flexibility and the freedom to give concrete form to your ideas without being shackled by size.

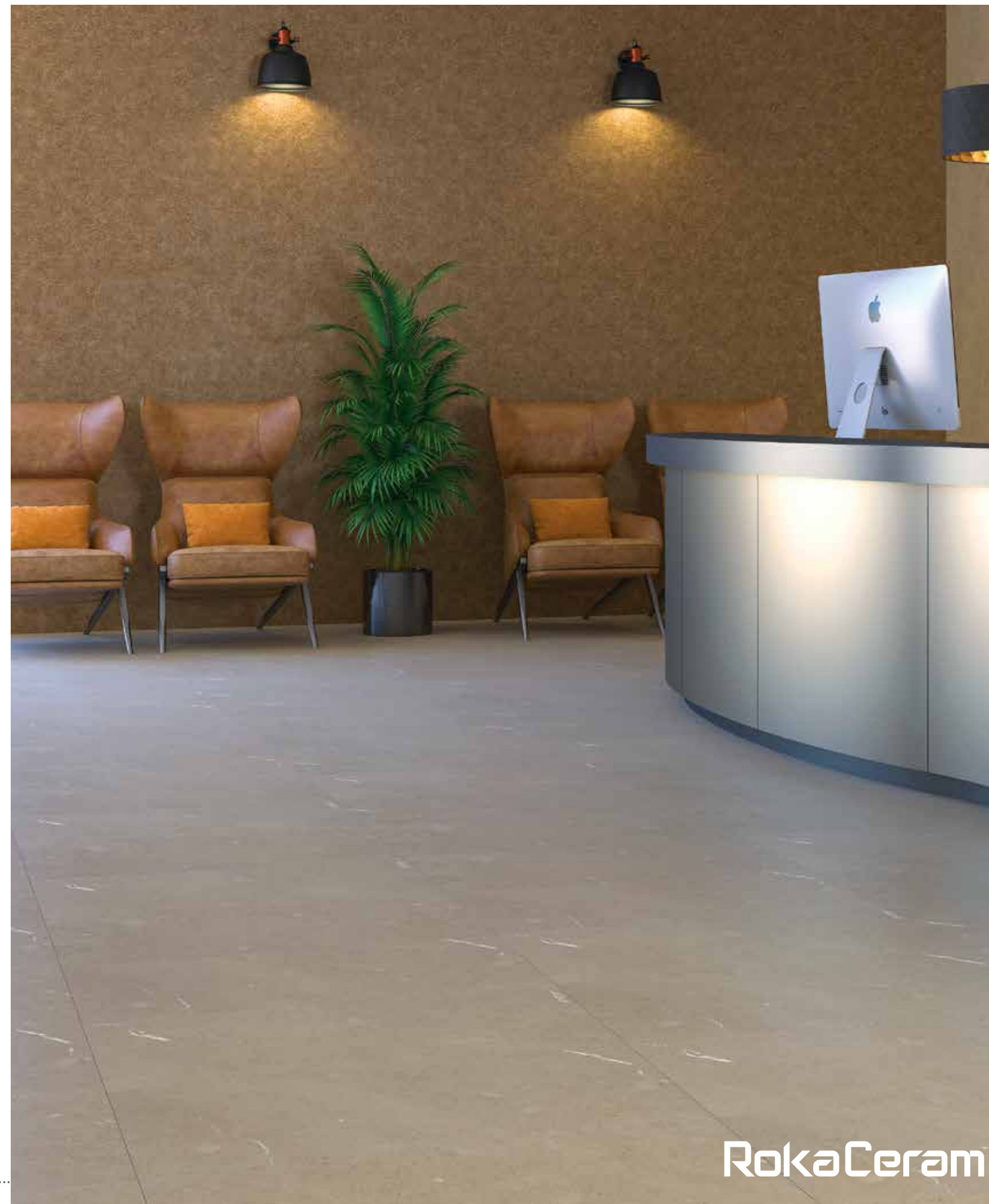
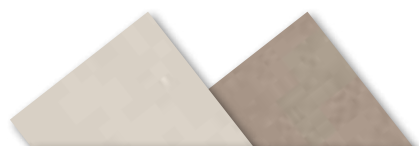



TRAINA LIGHT BONE



TRAINA BROWN

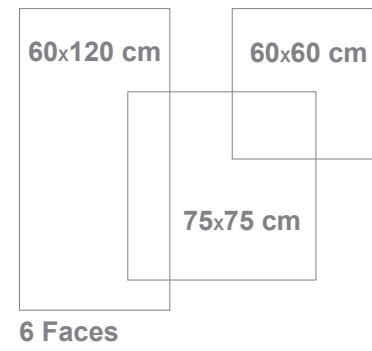

As you reach the summit, panting and puffing, you'd feel the pulses beneath your skin; yet, you rejoice in it. Valeria offers you the pleasure of climax and liberty.



Thanks to its native 1.1cm thickness, provides lightness and strength in all applications - even the ones you'd never even imagined.



Rokaceram offers unmatched project flexibility and the freedom to give concrete form to your ideas without being shackled by size.

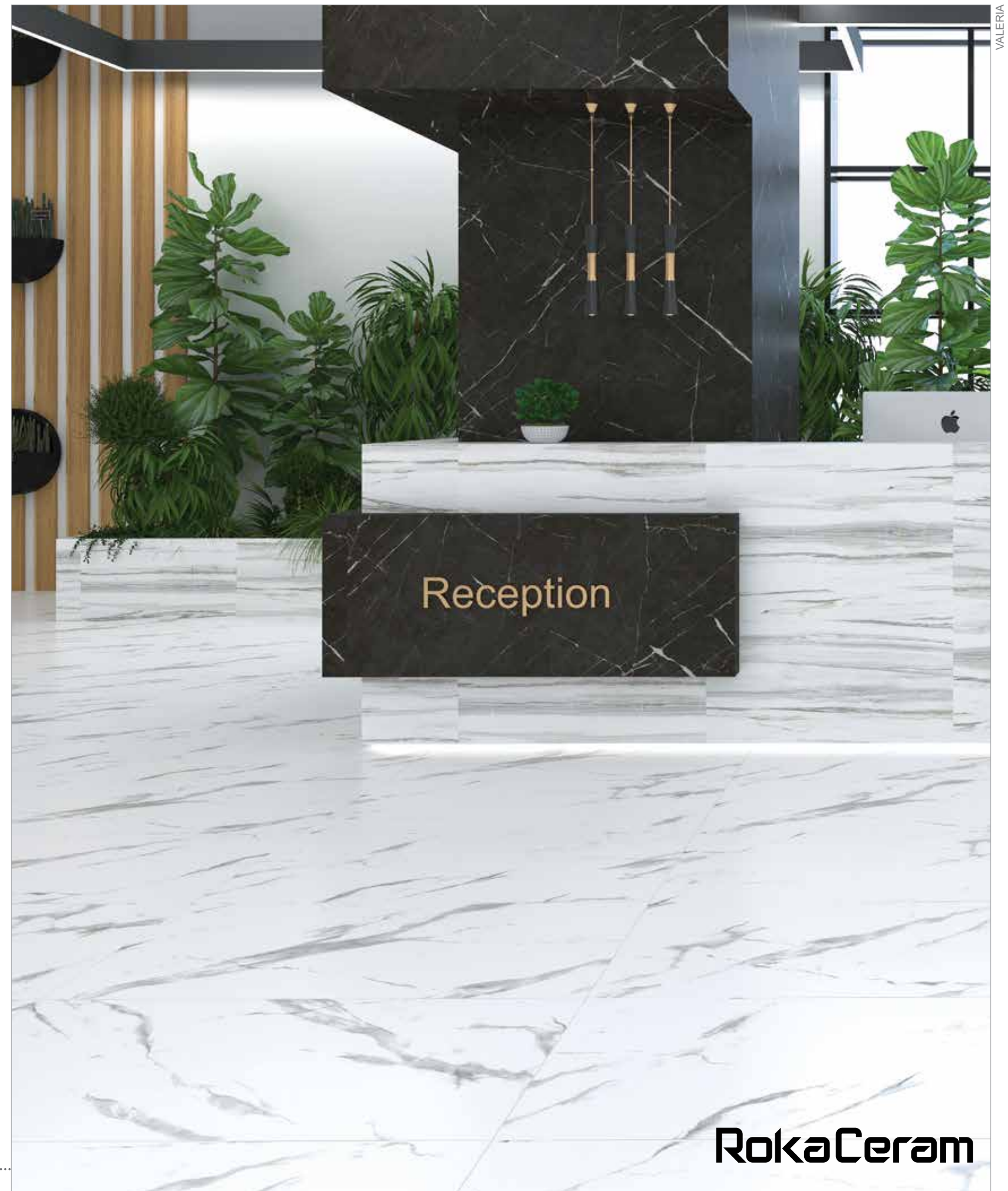

RokaCeram



VALERIA

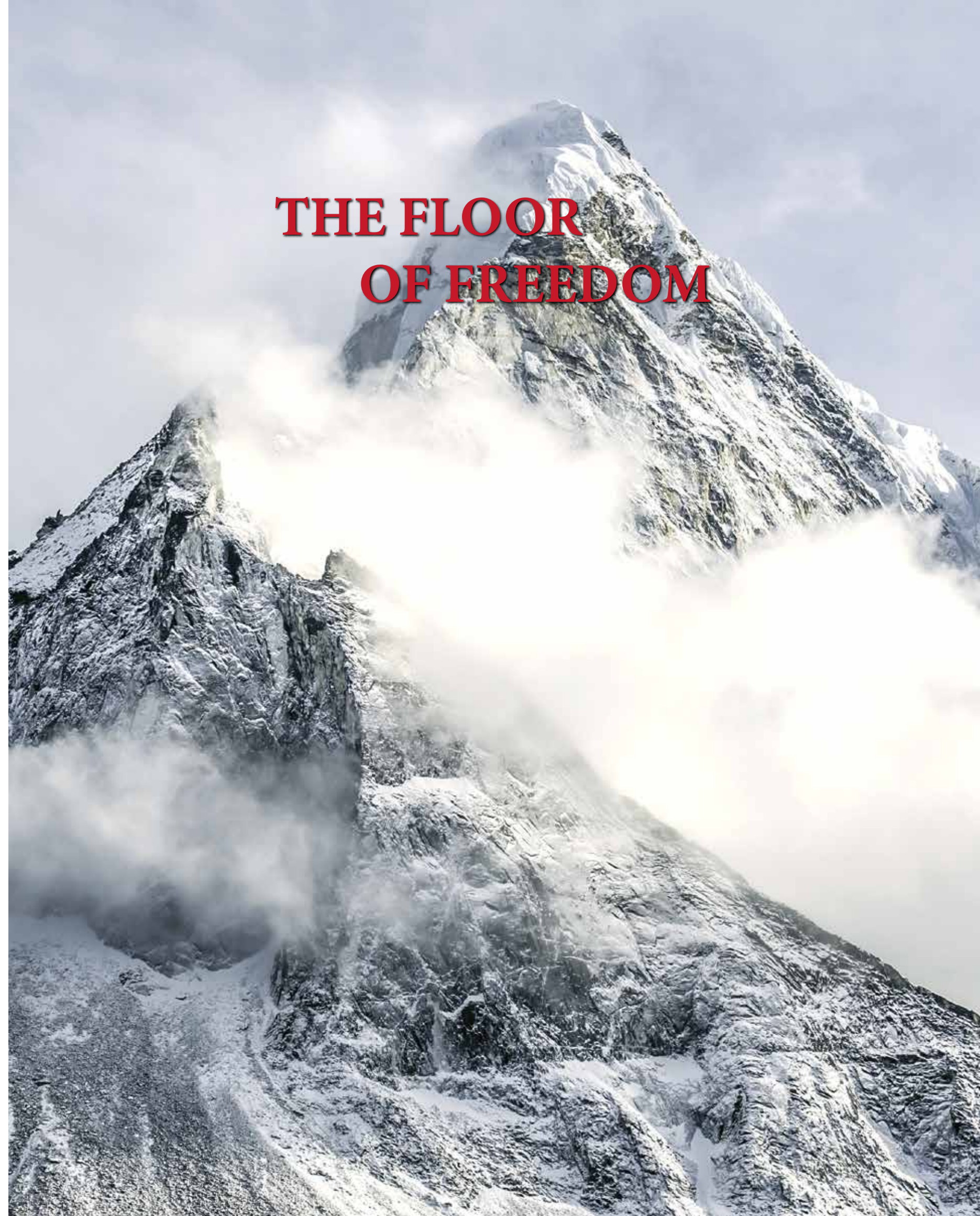

**THE FLOOR
OF FREEDOM**

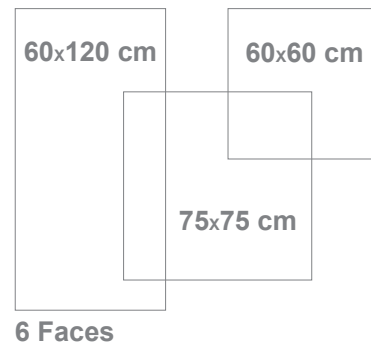

A virgin white giving meaning to color, or a silence defining sound and a distance translating into decor. That's Carrara.

 SPORT CENTER	 HEADQUARTER	 RESTAURANT	 HOTEL	 VENTILATED FACADES
 HOME	 SHOP	 HOSPITAL	 AIRPORT	 OFFICE
 FROST RESISTANCE	 RESIDENTIAL USE	 FLOOR TILES	 LIGHT COMMERCIAL	 WALL TILES



Thanks to its native 1.1cm thickness, provides lightness and strength in all applications - even the ones you'd never even imagined.



Rokaceram offers unmatched project flexibility and the freedom to give concrete form to your ideas without being shackled by size.

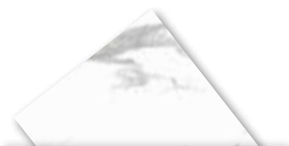

RokaCeram



CARRARA



COMMITTED TO SUSTAINABLE DEVELOPMENT

RokaCeram has taken on a global commitment to maintain an environmentally-friendly policy. Proof of the company's efforts to ensure clean and eco-friendly business activities are the implementation of an Environmental Management System in compliance standards.

In order to reduce and prevent environmental impacts and guarantee an optimum waste management system, **RokaCeram** has a sizable Quality Control & Environmental Department whose experts regularly assess the environmental impacts of the firm's activities. In addition, at least once a year external audits are conducted to evaluate the firm's actions and guarantee its commitment to sustainable development.

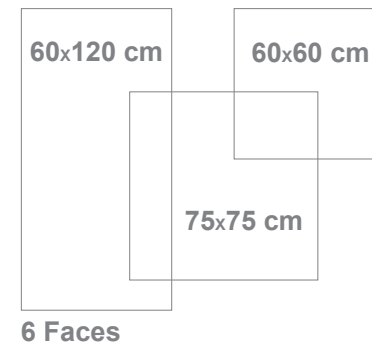

A return to the roots, to the soil, and to what you're originating from. Take a look at it, and you'd notice the brevity of moments and the recurrence of hope and effort, day in day out and you'd take a step forward proceeding and succeeding. Cement is a design of such a vibe and such a belief.

SPORT CENTER	HEADQUARTER	RESTAURANT	HOTEL	VENTILATED FACADES
HOME	SHOP	HOSPITAL	AIRPORT	OFFICE
FROST RESISTANCE	RESIDENTIAL USE	FLOOR TILES	LIGHT COMMERCIAL	WALL TILES



Thanks to its native 1.1cm thickness, provides lightness and strength in all applications - even the ones you'd never even imagined.



Rokaceram offers unmatched project flexibility and the freedom to give concrete form to your ideas without being shackled by size.

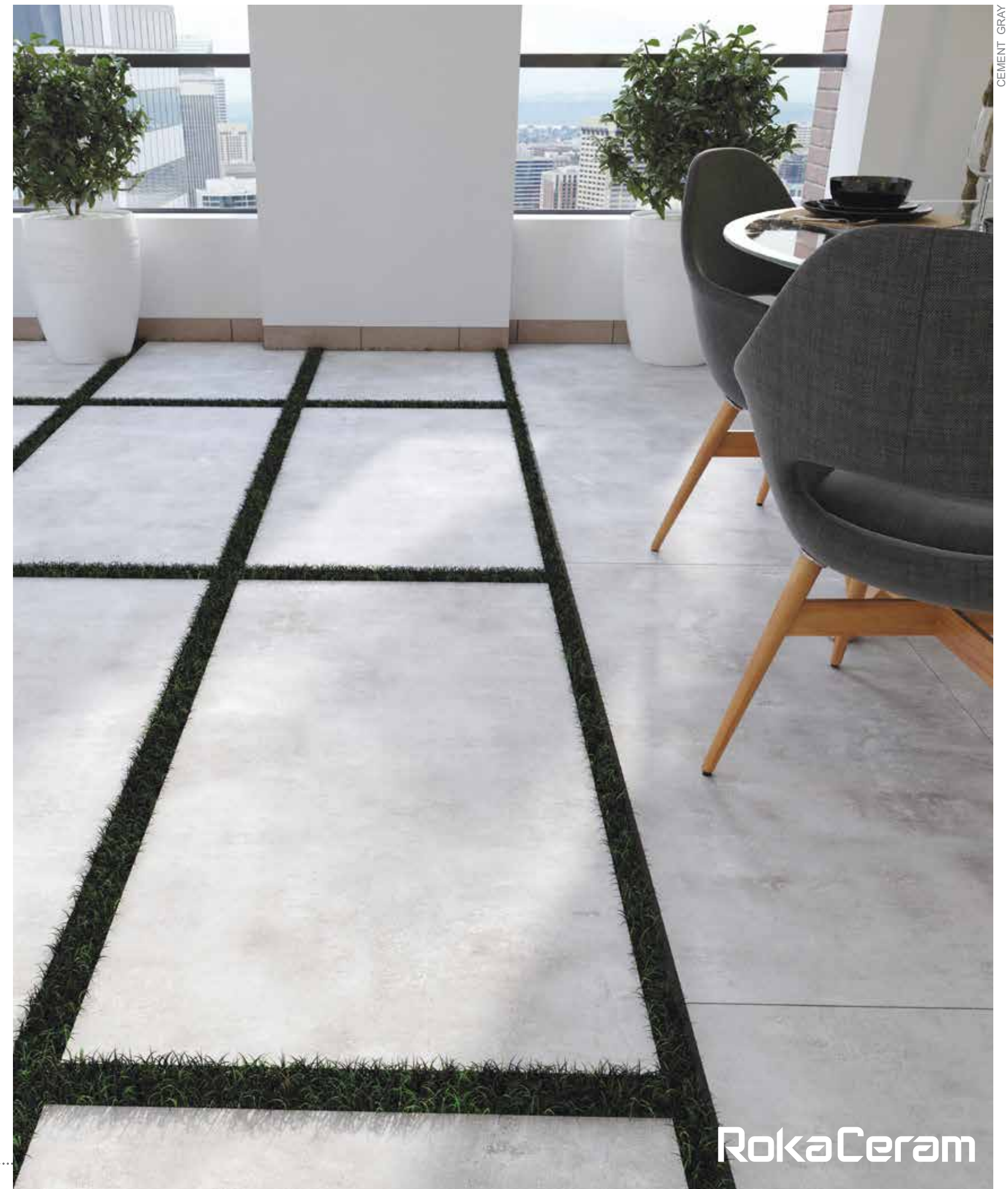

RokaCeram



CEMENT GRAY

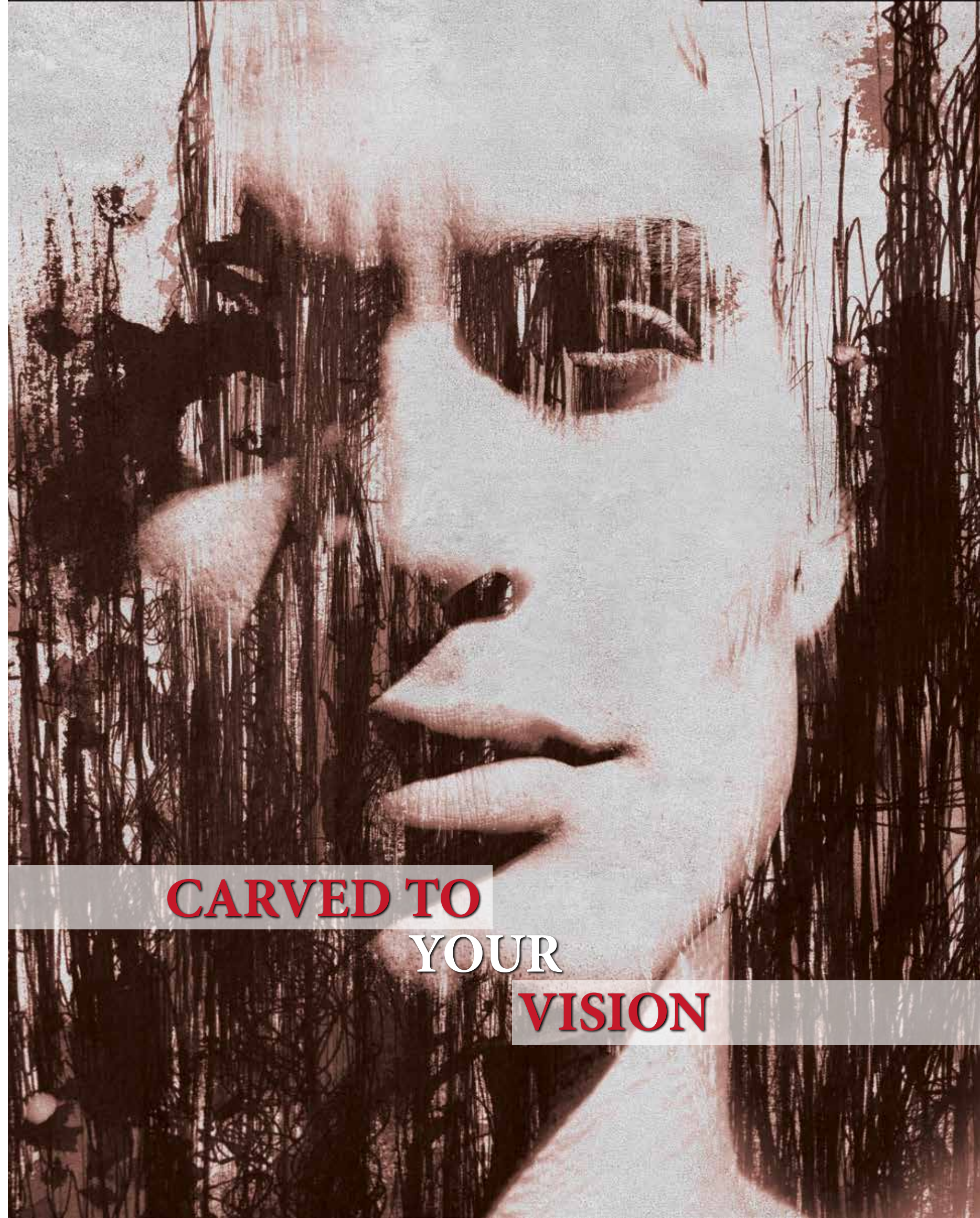

CARVED TO
YOUR
VISION

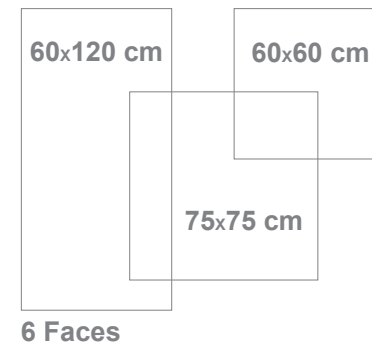

As limpid as water and as elegant as waterfall, as roaring as a river and as pristine as a nature; this is how Lumina decorates the decor.



Thanks to its native 1.1cm thickness, provides lightness and strength in all applications - even the ones you'd never even imagined.



Rokaceram offers unmatched project flexibility and the freedom to give concrete form to your ideas without being shackled by size.





LUMINA ARENA



LUMINA BONE

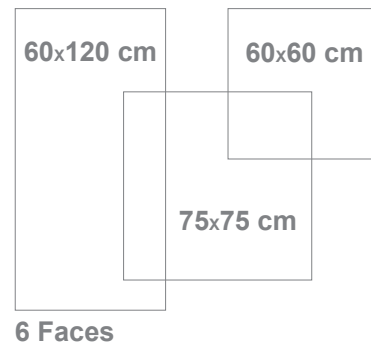

There must be a roar, to break, to give light and to rebuild. To rebuild anew, solid and safe and sound. You've got to get lost in grace, in shock and awe. You've got to take steps to splash light on the dark, and spray love on the shack.



Thanks to its native 1.1cm thickness, provides lightness and strength in all applications - even the ones you'd never even imagined.



Rokaceram offers unmatched project flexibility and the freedom to give concrete form to your ideas without being shackled by size.

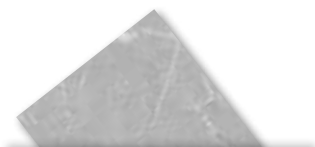

RokaCeram



MONTANA GRAY

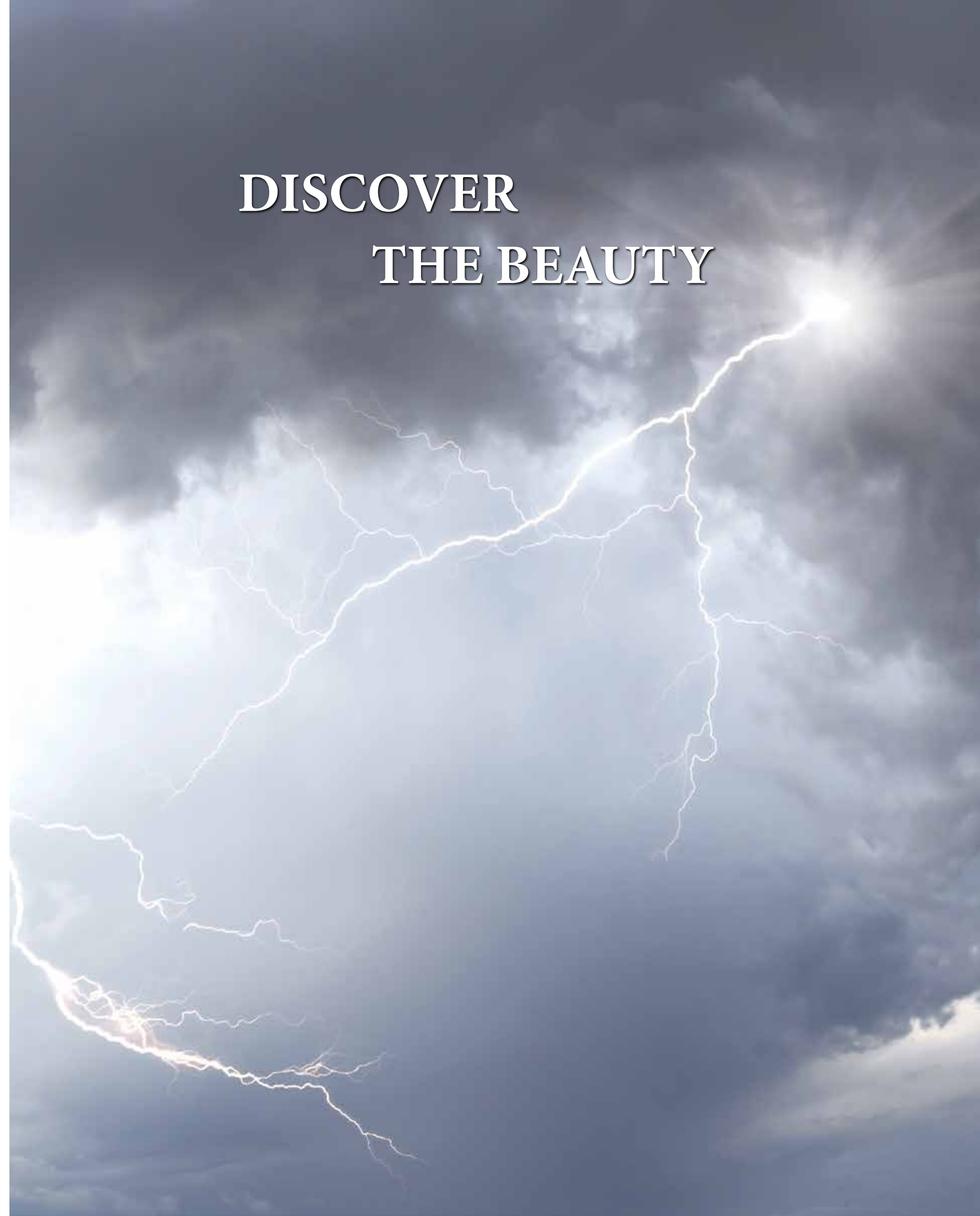

**DISCOVER
THE BEAUTY**

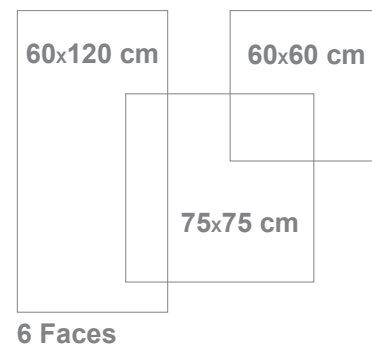

The brush sways, and the views of a Spring emerge; color dripples from the ink and decorates the mansion by color and water. Parden is such a painting, so elaborate, so genuine.



Thanks to its native 1.1cm thickness, provides lightness and strength in all applications - even the ones you'd never even imagined.



Rokaceram offers unmatched project flexibility and the freedom to give concrete form to your ideas without being shackled by size.

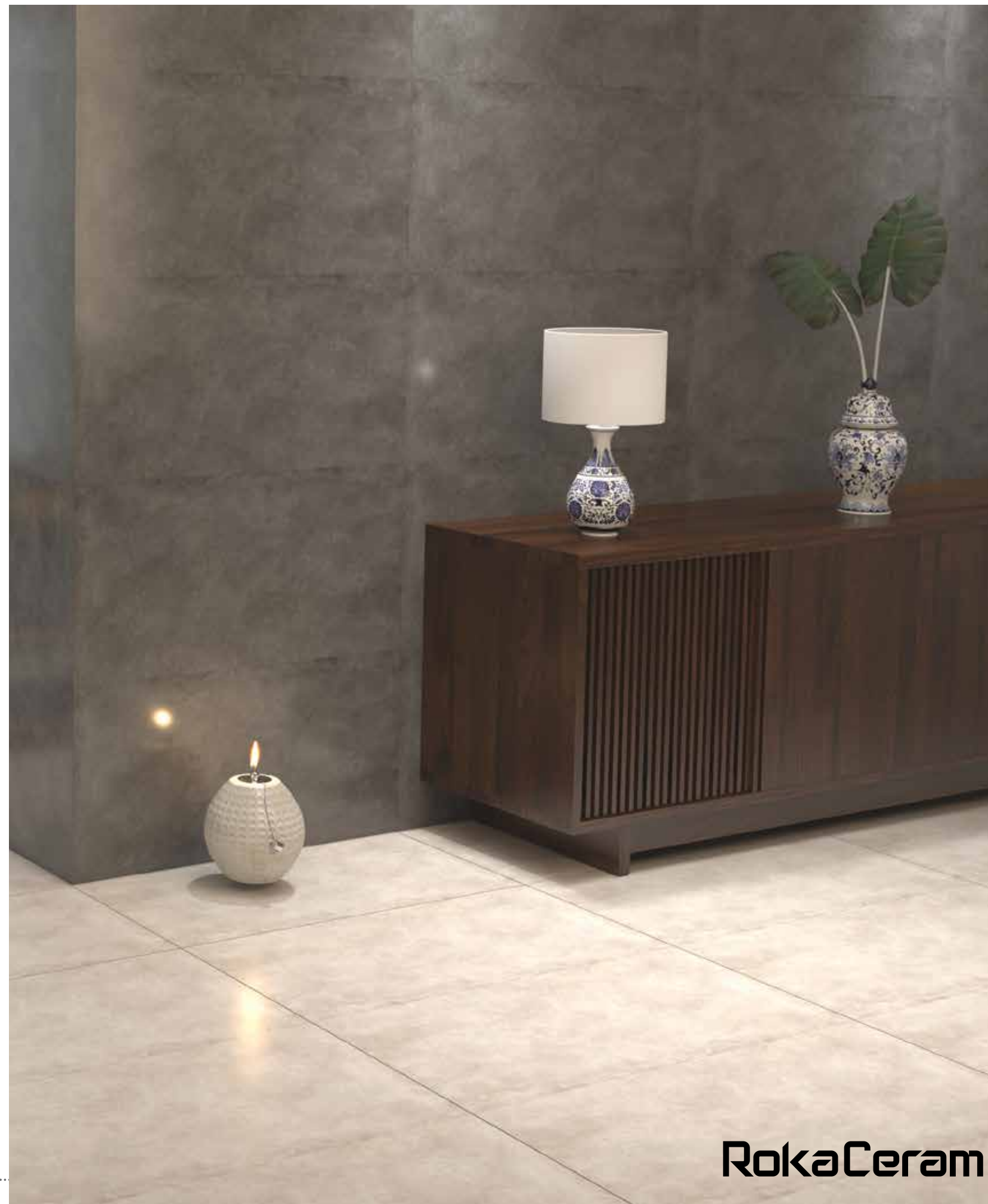

RokaCeram

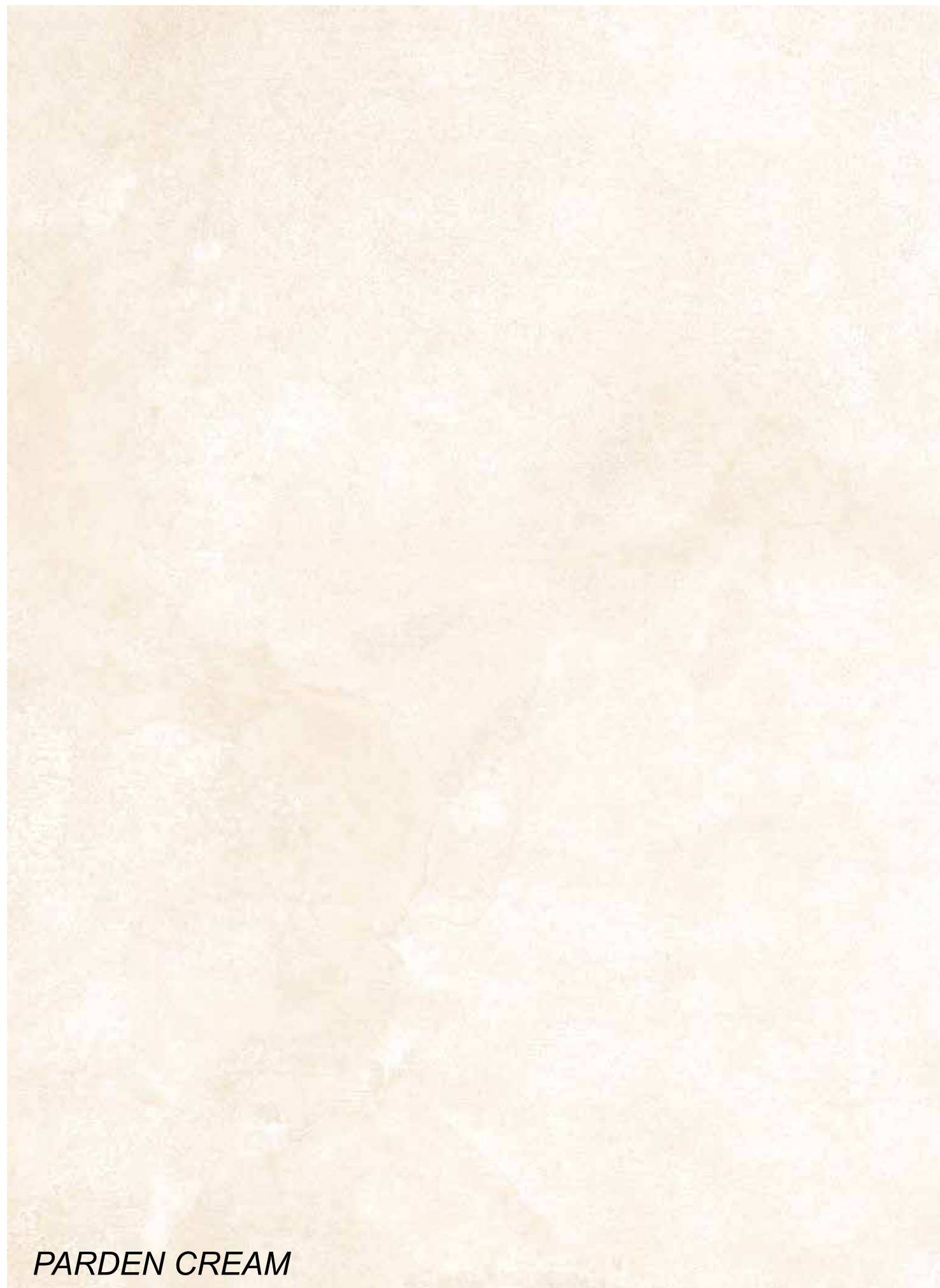

PARDEN CREAM



PARDEN GRIS



PARDEN CREAM DECOR

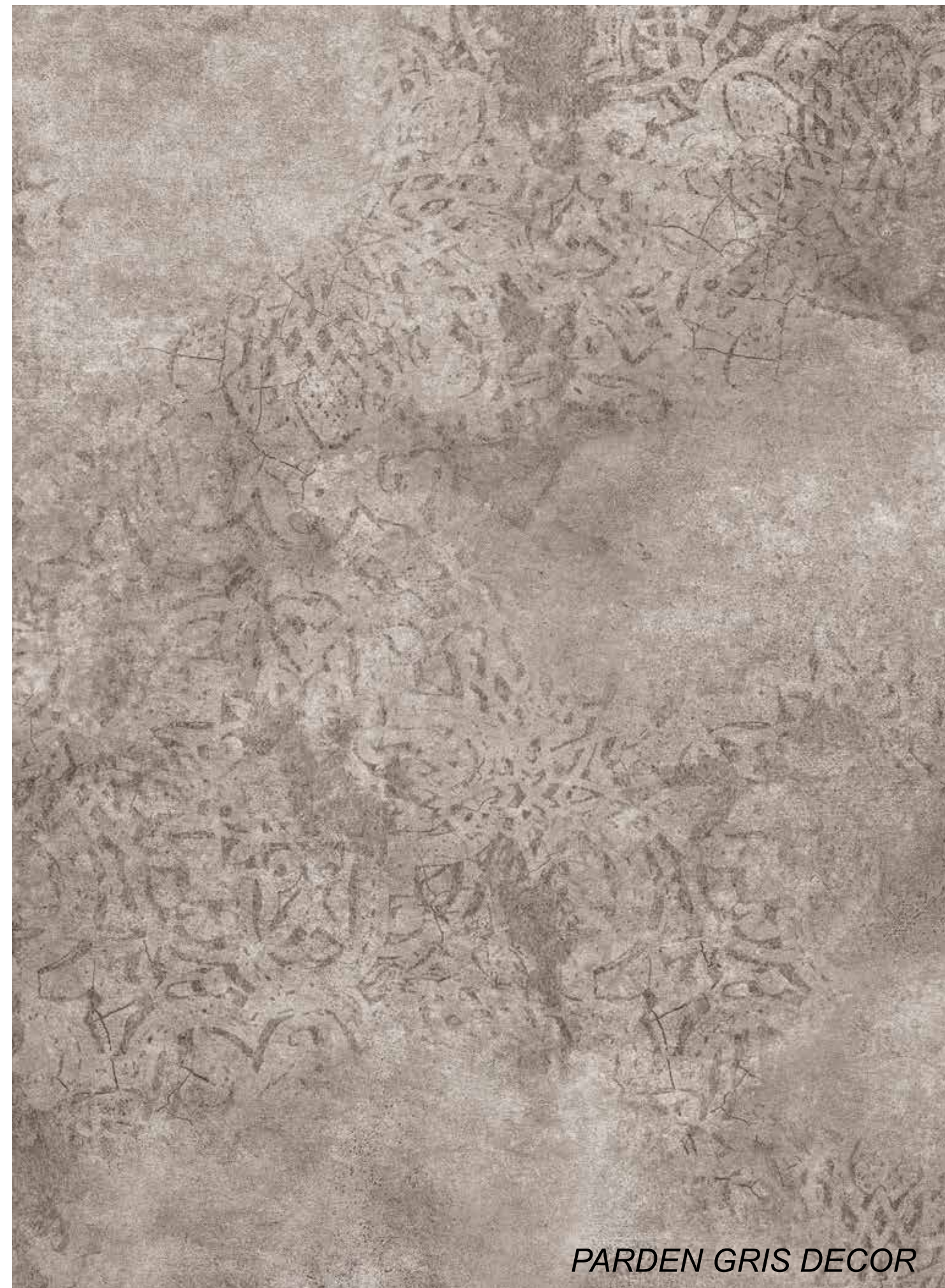

PARDEN GRIS DECOR

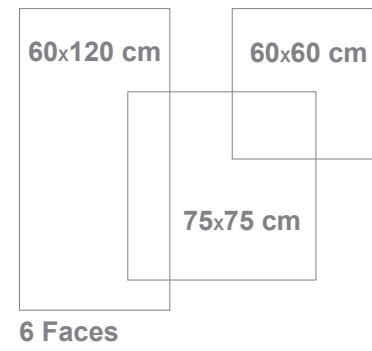

Finding a way is the nature's behavior. Satiation from divergence to convergence, from line to curvature, from hope to action, from stillness to transition, from wall to path. Scabos is such a profile.



Thanks to its native 1.1cm thickness, provides lightness and strength in all applications - even the ones you'd never even imagined.



Rokaceram offers unmatched project flexibility and the freedom to give concrete form to your ideas without being shackled by size.



RokaCeram



SCABOS BEIGE



SCABOS CREAM



SCABOS BROWN

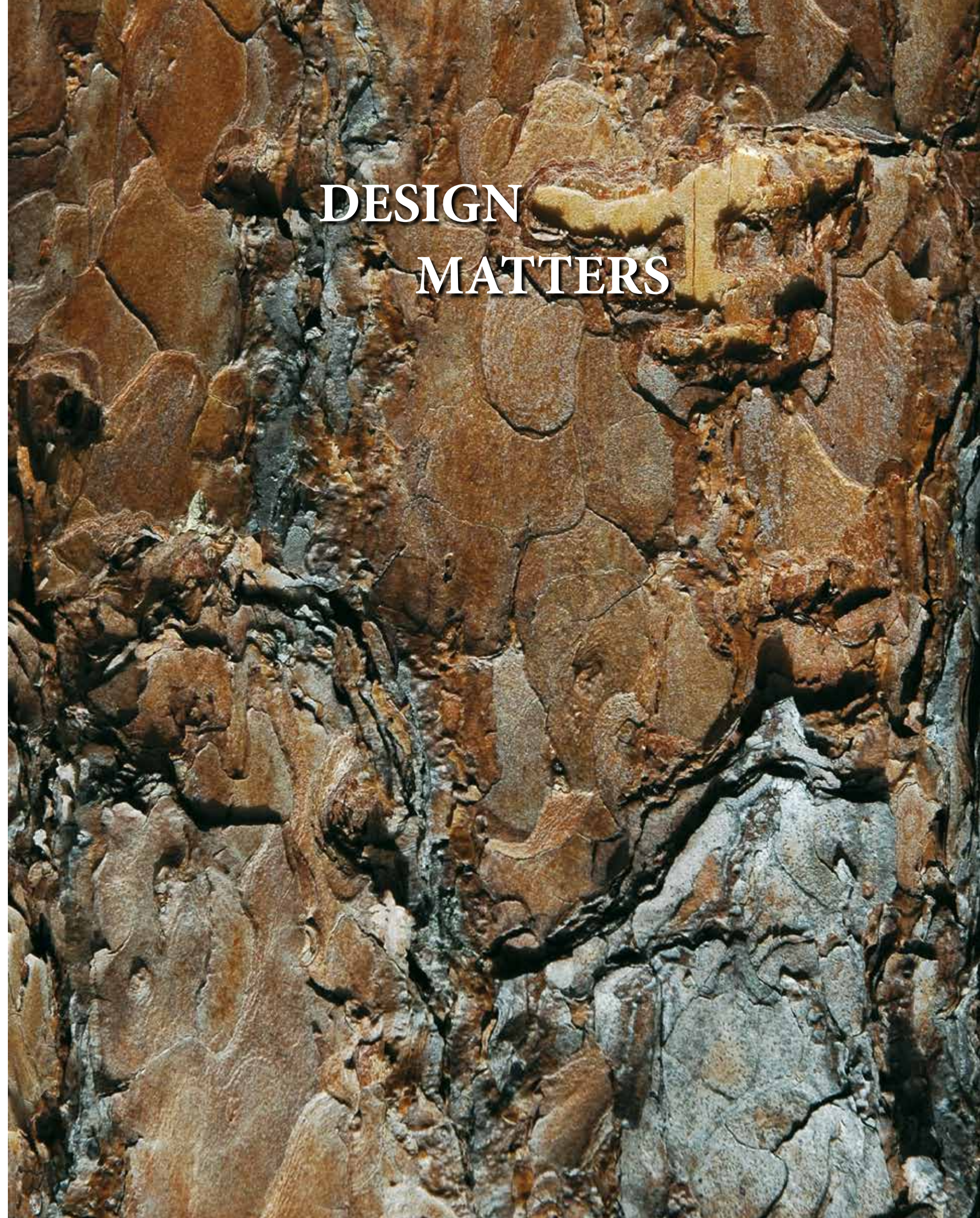

**DESIGN
MATTERS**

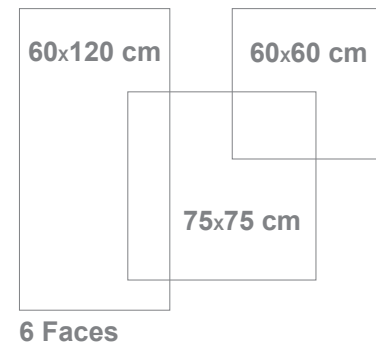

When you set your foot on, it is the heat of the sea and the thirst of the sun. You cool down, take a step, and when out, your exhaustion is gone. Grit is a picture of this fantasy journey.



Thanks to its native 1.1cm thickness, provides lightness and strength in all applications - even the ones you'd never even imagined.



Rokaceram offers unmatched project flexibility and the freedom to give concrete form to your ideas without being shackled by size.



RokaCeram



GRIT WHITE



GRIT ANTHRACITE

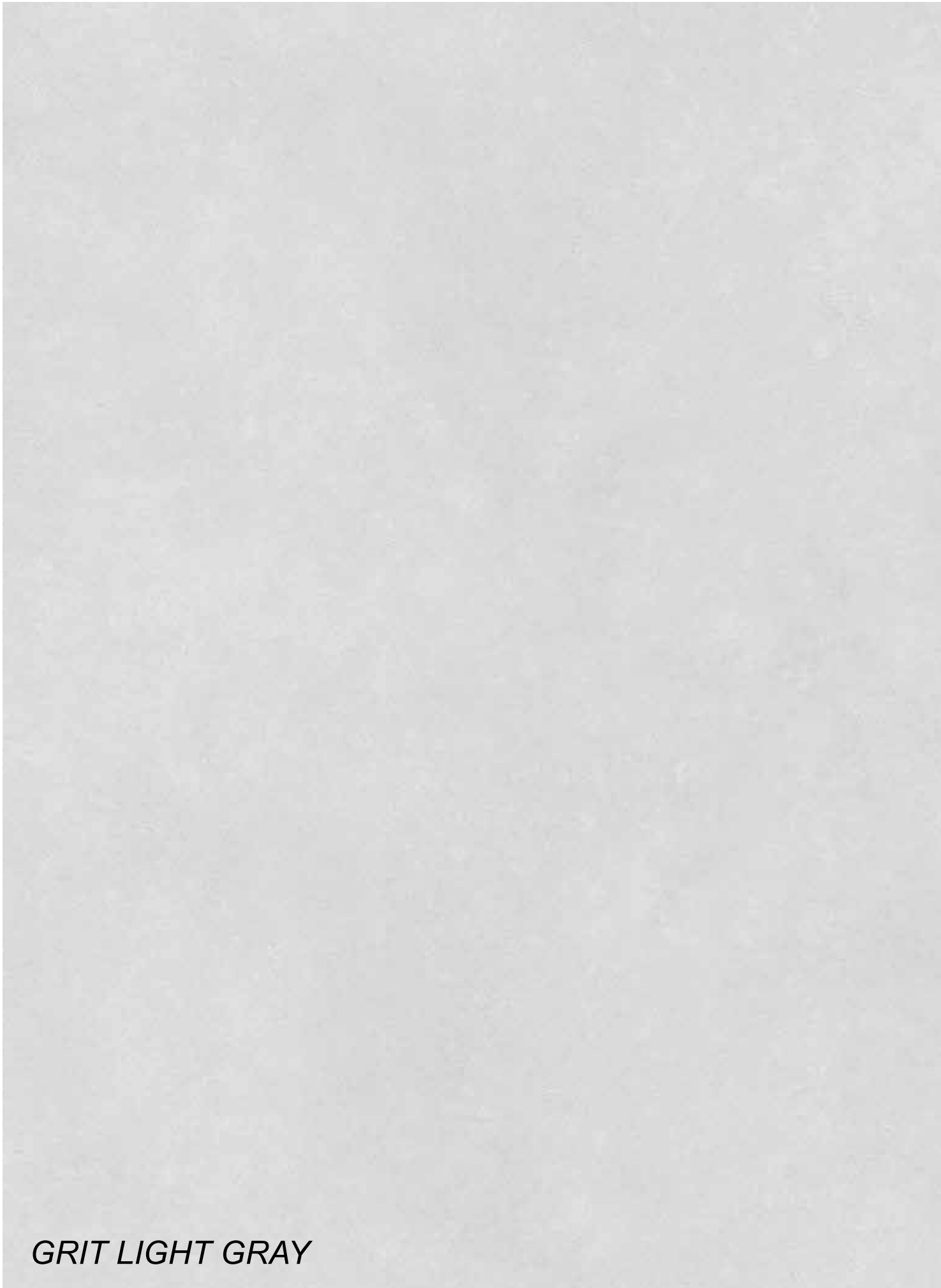

GRIT LIGHT GRAY

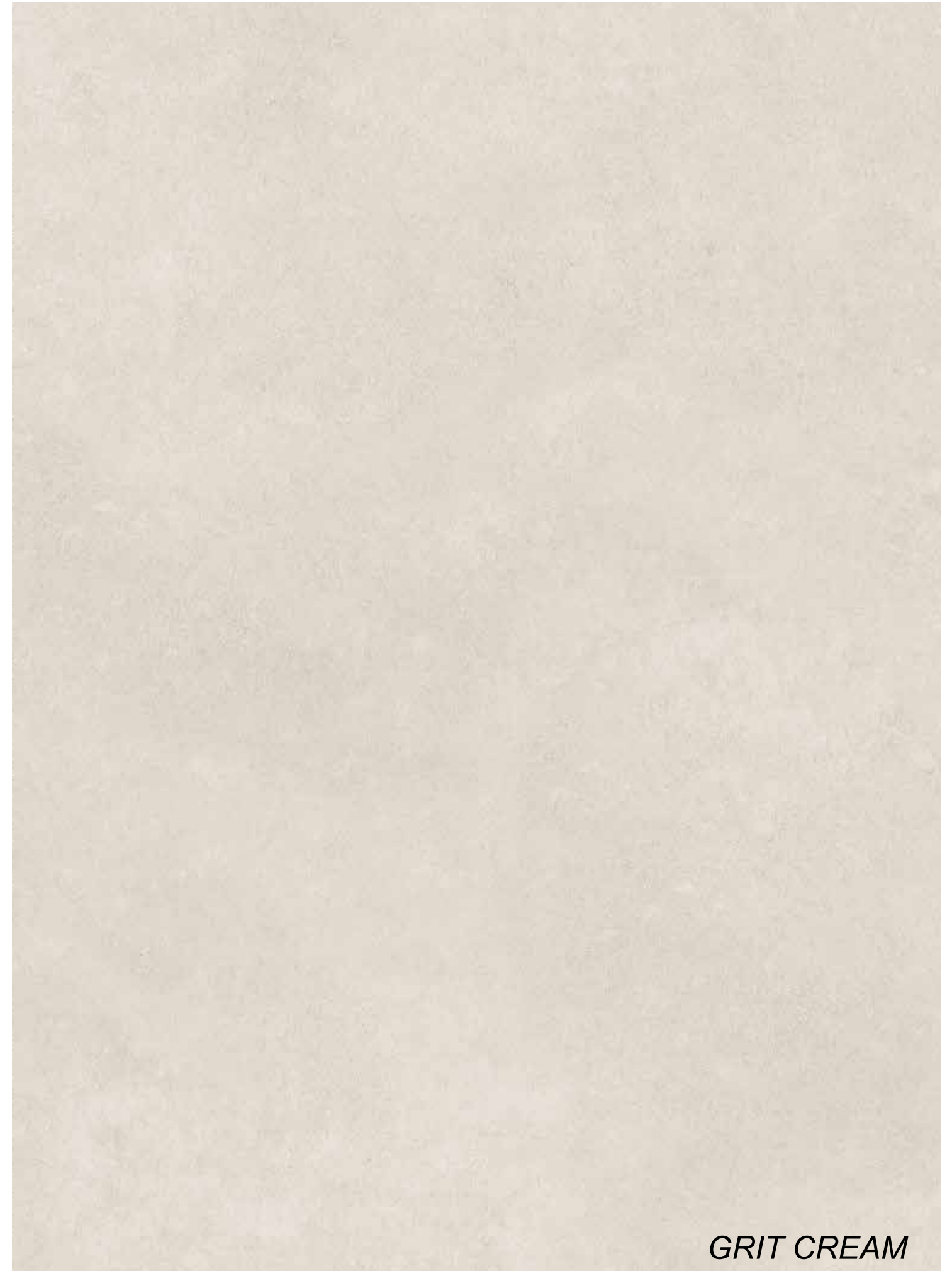

GRIT CREAM

GRIT BEIGE

UNEXPECTED
PEACE WITH
TILES

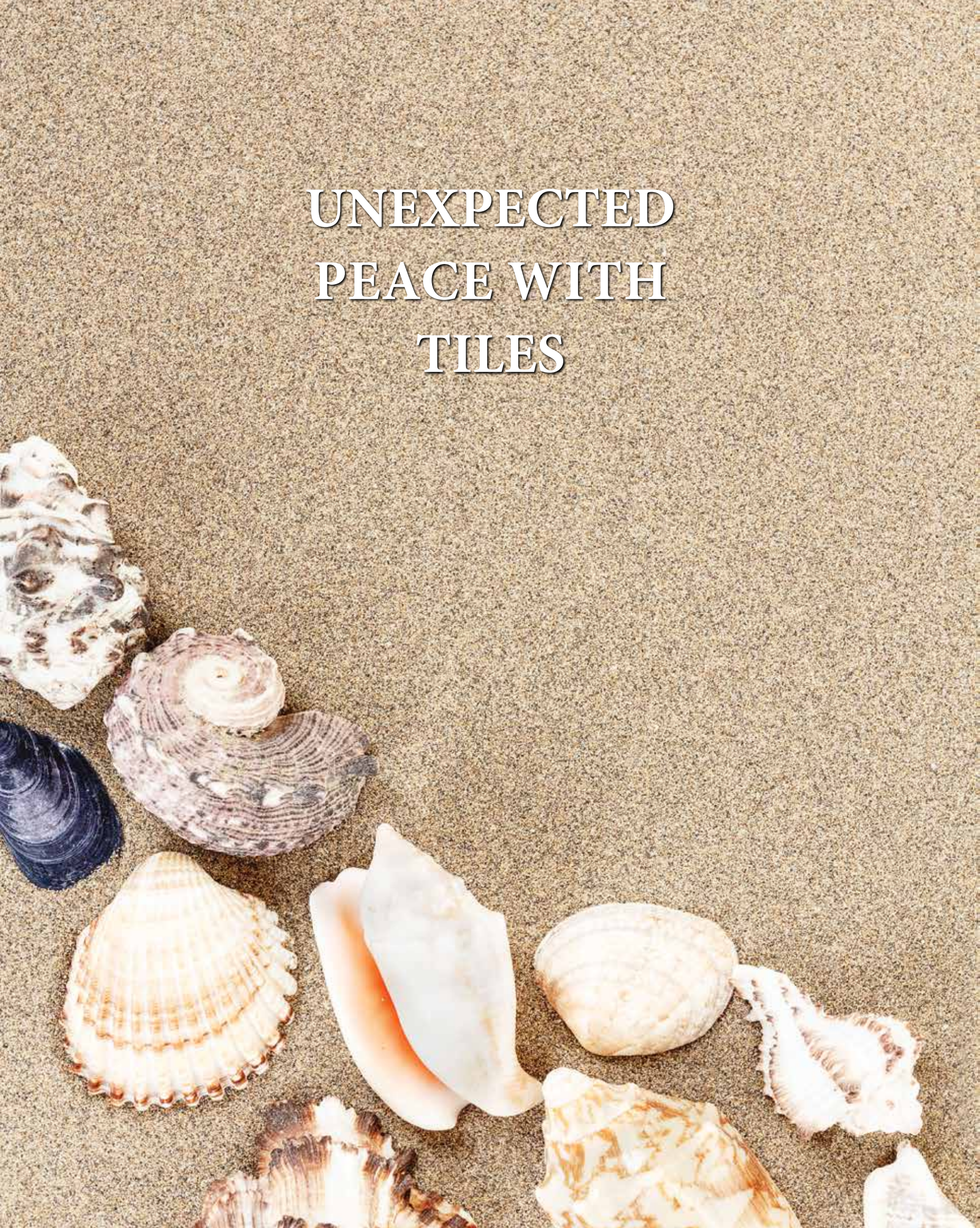

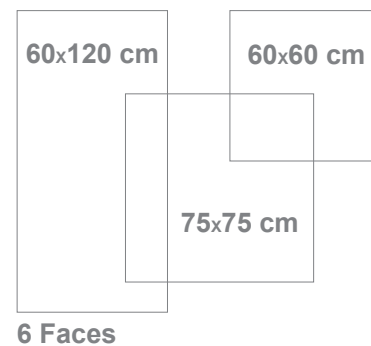

Head down and calmly go through this hardship. Focus on your goal; set your mind and heart on it to get there, step by step. Open your eyes to this beauty, to this strength and to this struggle of moments and colors.



Thanks to its native 1.1cm thickness, provides lightness and strength in all applications - even the ones you'd never even imagined.



Rokaceram offers unmatched project flexibility and the freedom to give concrete form to your ideas without being shackled by size.

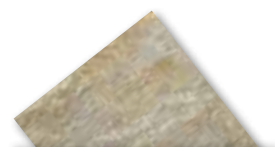

RokaCeram



PATRICE

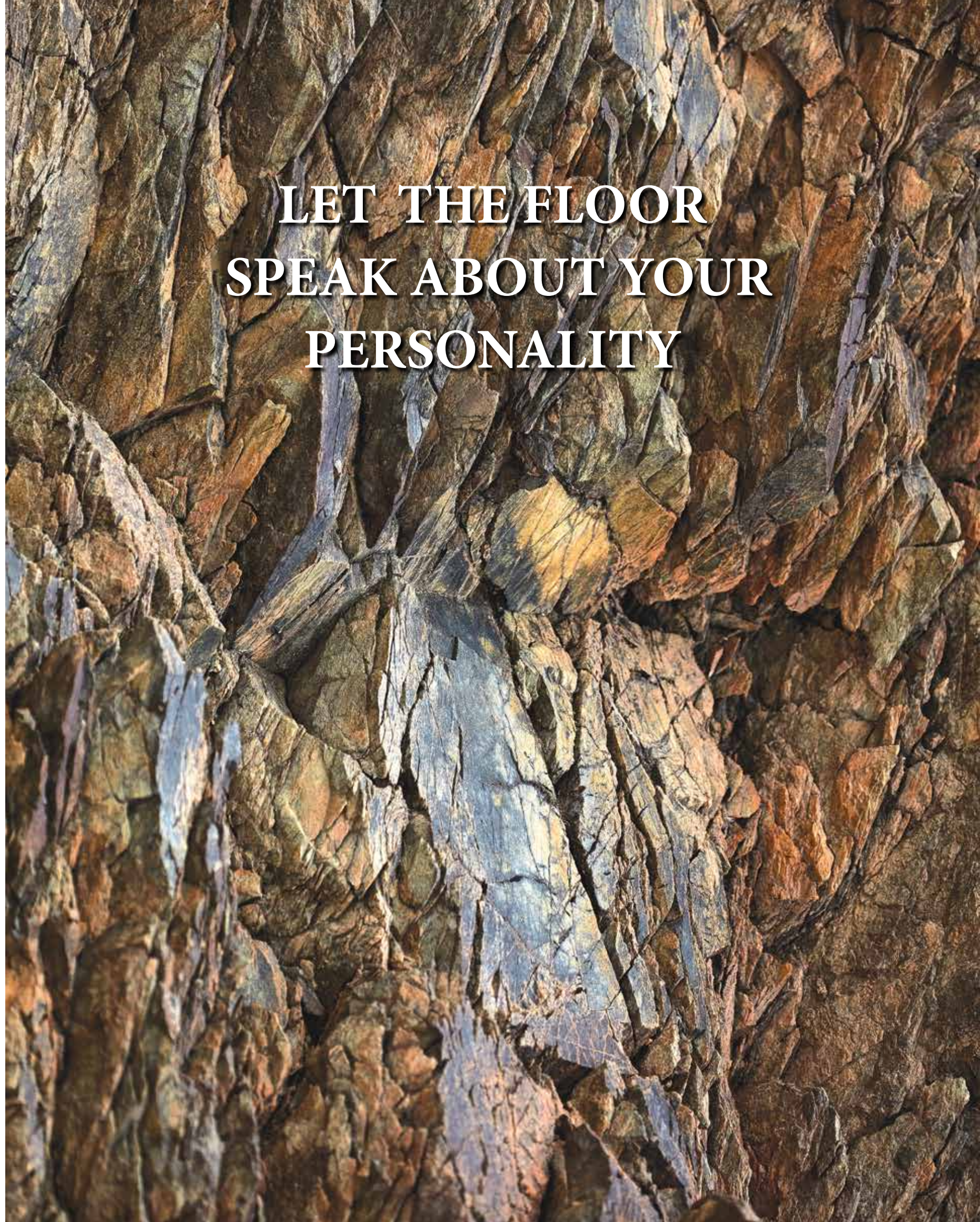

**LET THE FLOOR
SPEAK ABOUT YOUR
PERSONALITY**

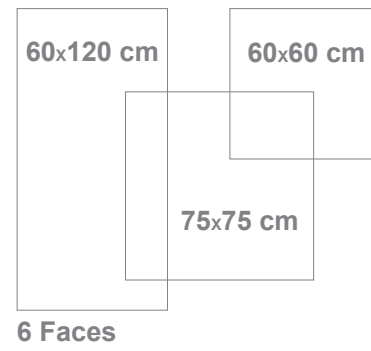

Dream with the light shining in the dark and along the happenings in this dark and go through the maze of imagination and enjoy a serene dream.



Thanks to its native 1.1cm thickness, provides lightness and strength in all applications - even the ones you'd never even imagined.



Rokaceram offers unmatched project flexibility and the freedom to give concrete form to your ideas without being shackled by size.



RokaCeram



COPPER OLIVE



COPPER BEIGE



COPPER GRIS



COPPER MARRON

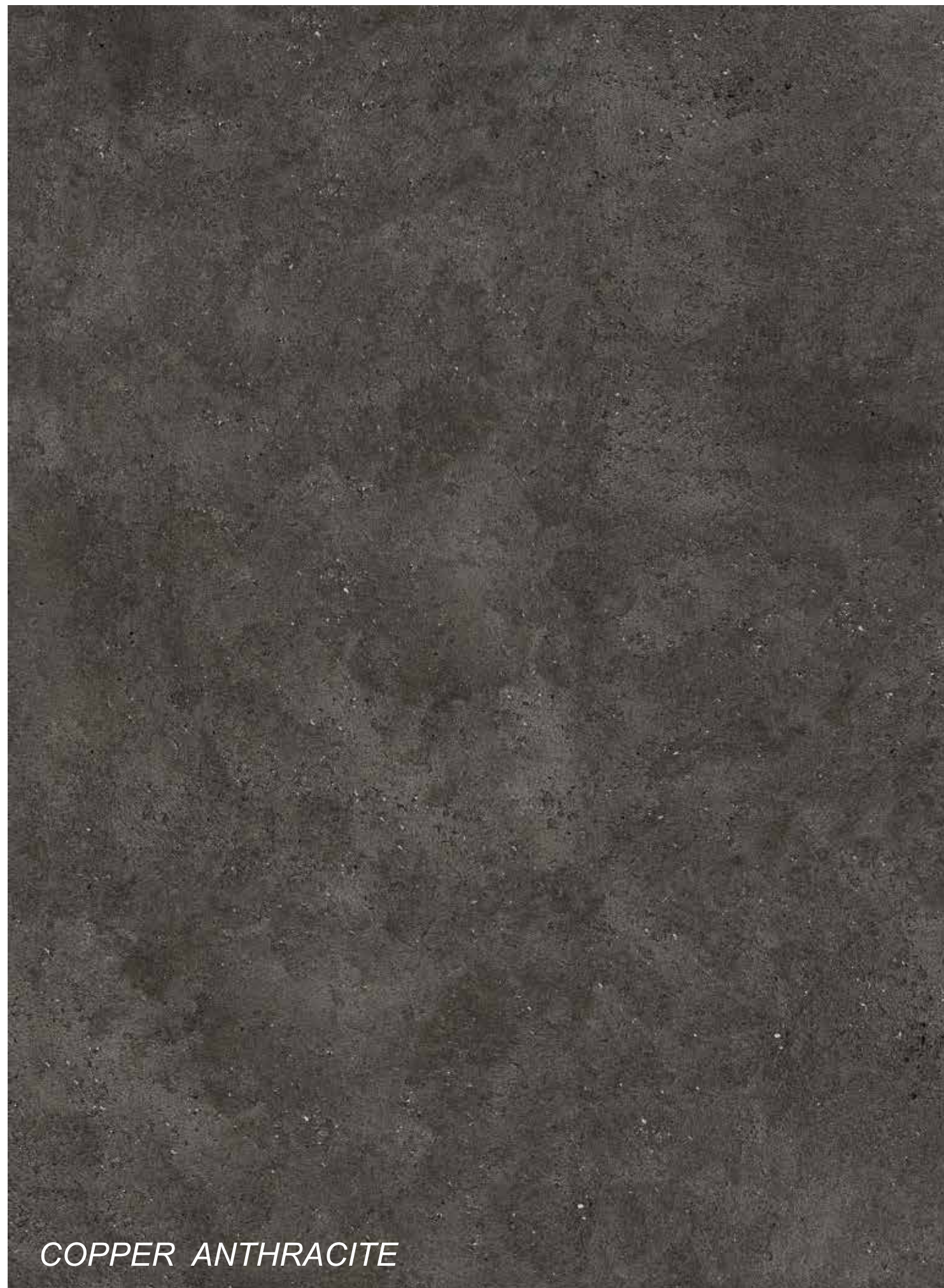

COPPER ANTHRACITE

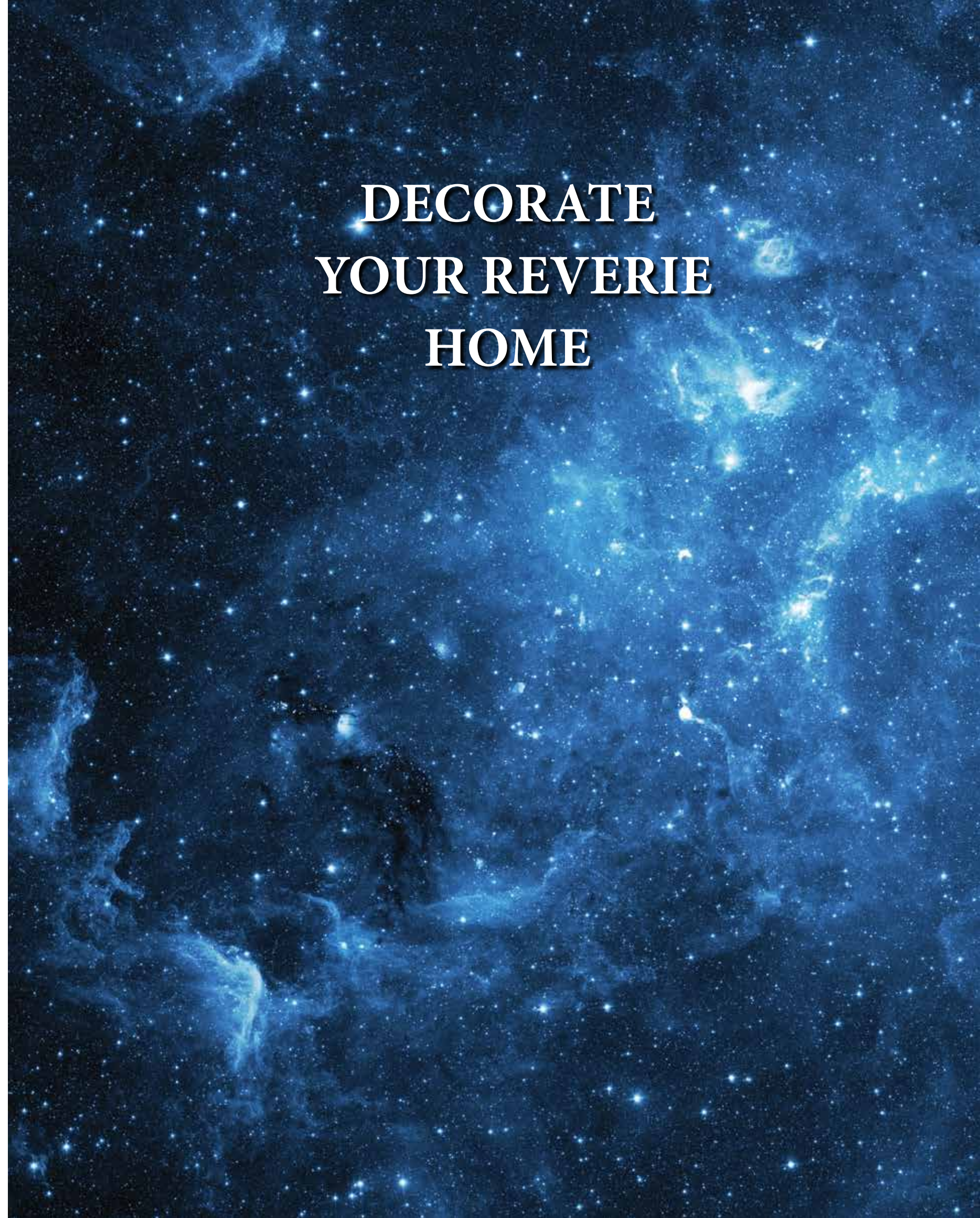

**DECORATE
YOUR REVERIE
HOME**

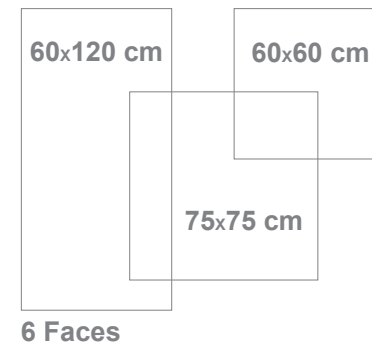

Dream with the light shining in the dark and along the happenings in this dark and go through the maze of imagination and enjoy a serene dream.



Thanks to its native 1.1cm thickness, provides lightness and strength in all applications - even the ones you'd never even imagined.



Rokaceram offers unmatched project flexibility and the freedom to give concrete form to your ideas without being shackled by size.

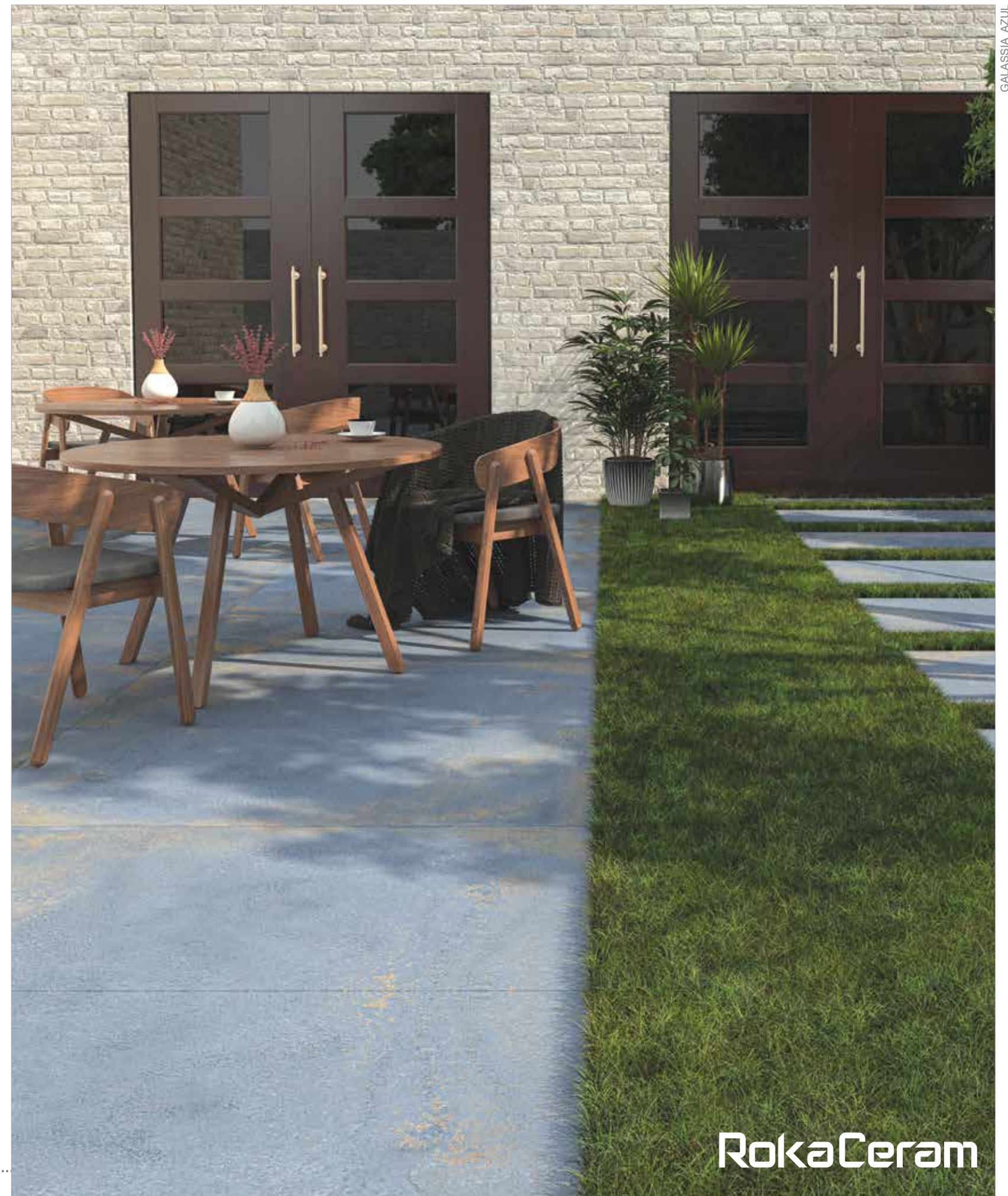

RokaCeram



GALASSIA OLIVE



GALASSIA ANTHRACITE



GALASSIA AZUL

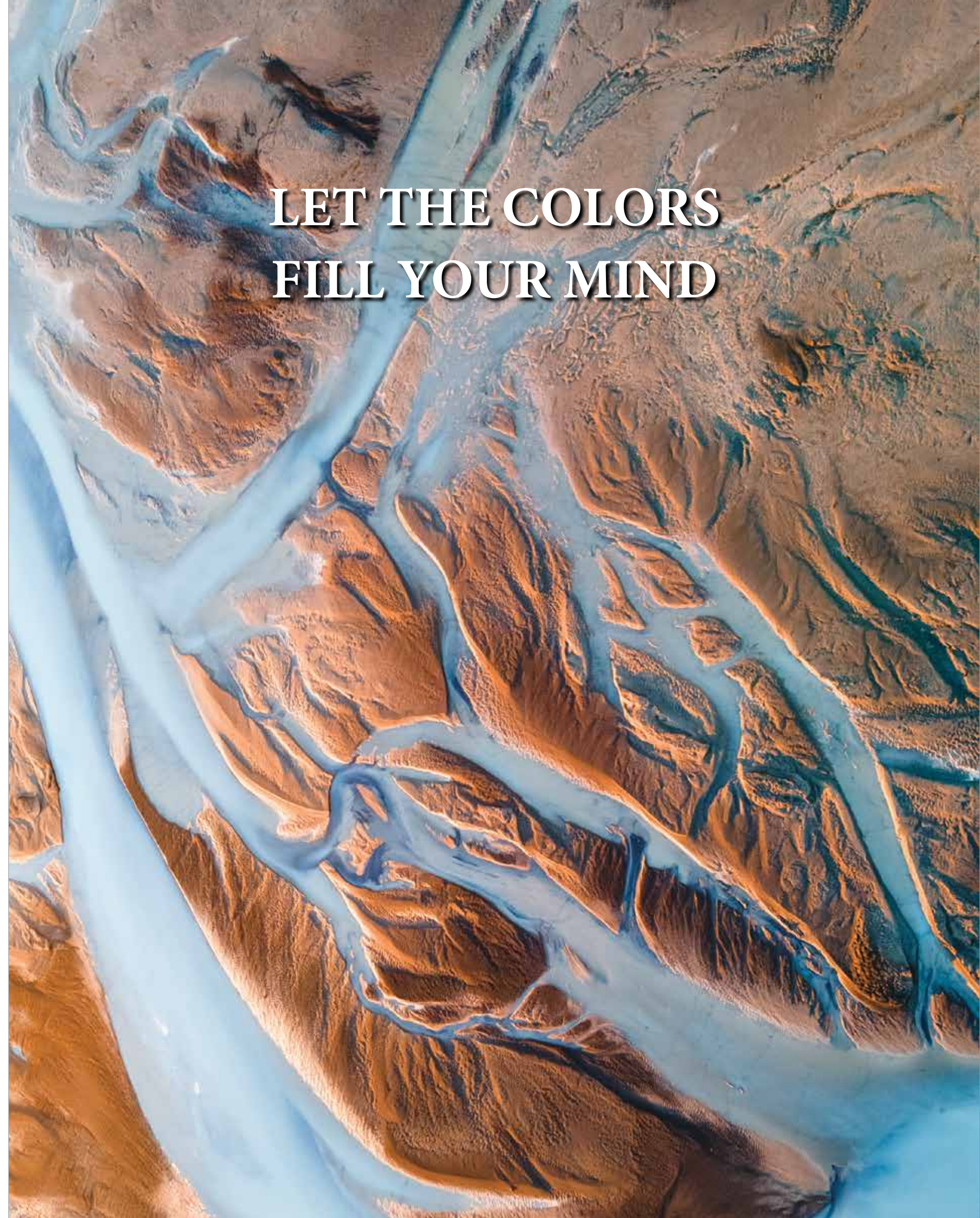

**LET THE COLORS
FILL YOUR MIND**

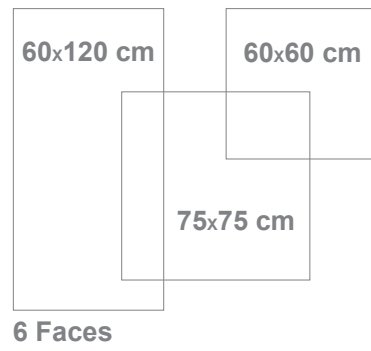

 SPORT CENTER	 HEADQUARTER	 RESTAURANT	 HOTEL	 VENTILATED FACADES
 HOME	 SHOP	 HOSPITAL	 AIRPORT	 OFFICE
 FROST RESISTANCE	 RESIDENTIAL USE	 FLOOR TILES	 LIGHT COMMERCIAL	 WALL TILES



Thanks to its native 1.1cm thickness, provides lightness and strength in all applications - even the ones you'd never even imagined.



Rokaceram offers unmatched project flexibility and the freedom to give concrete form to your ideas without being shackled by size.



CHARM WHITE

RokaCeram



CHARM WHITE

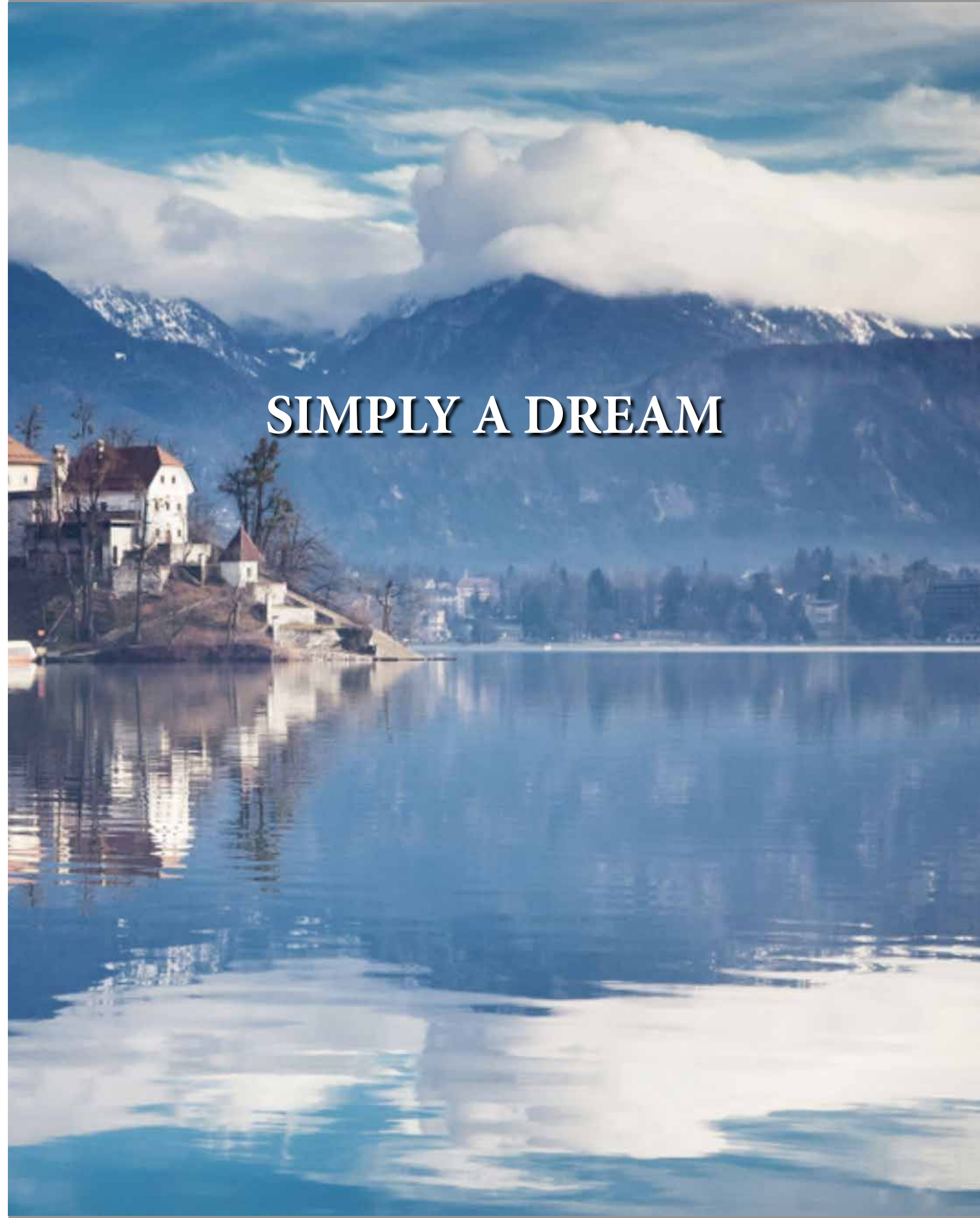

SIMPLY A DREAM

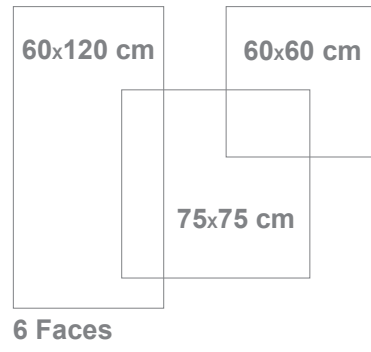

Thanks to its native 1.1cm thickness, provides lightness and strength in all applications - even the ones you'd never even imagined.



Rokaceram offers unmatched project flexibility and the freedom to give concrete form to your ideas without being shackled by size.

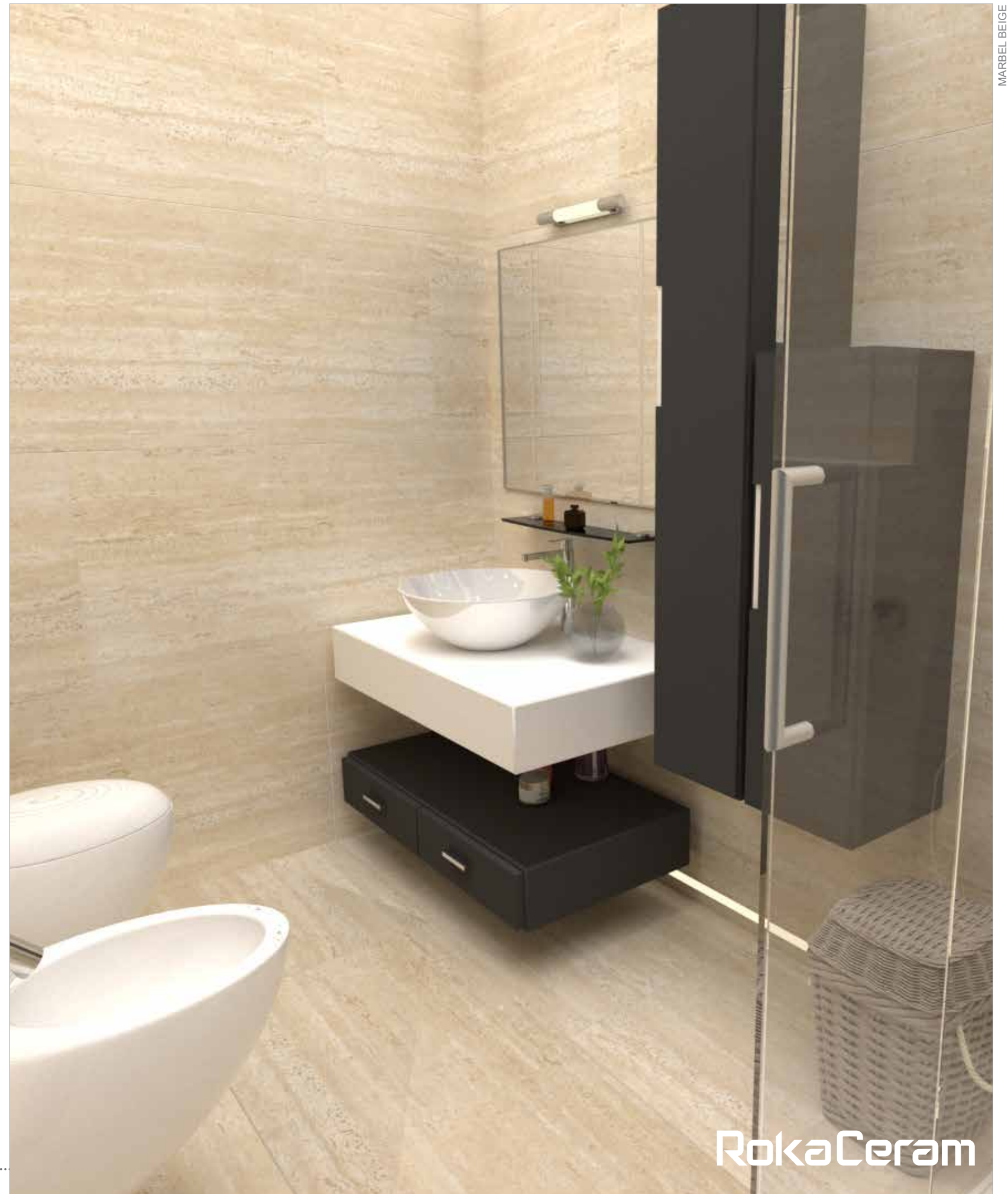

RokaCeram



MARBEL BEIGE

**FLOOR
IT THE
WAY YOU
WANT**

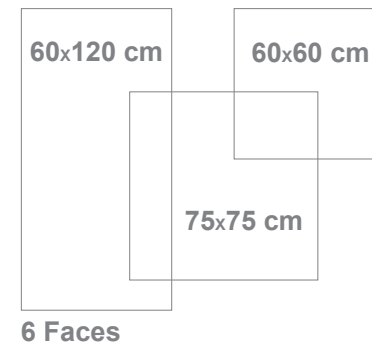

 SPORT CENTER	 HEADQUARTER	 RESTAURANT	 HOTEL	 VENTILATED FACADES
 HOME	 SHOP	 HOSPITAL	 AIRPORT	 OFFICE
 FROST RESISTANCE	 RESIDENTIAL USE	 FLOOR TILES	 LIGHT COMMERCIAL	 WALL TILES



Thanks to its native 1.1cm thickness, provides lightness and strength in all applications - even the ones you'd never even imagined.



Rokaceram offers unmatched project flexibility and the freedom to give concrete form to your ideas without being shackled by size.

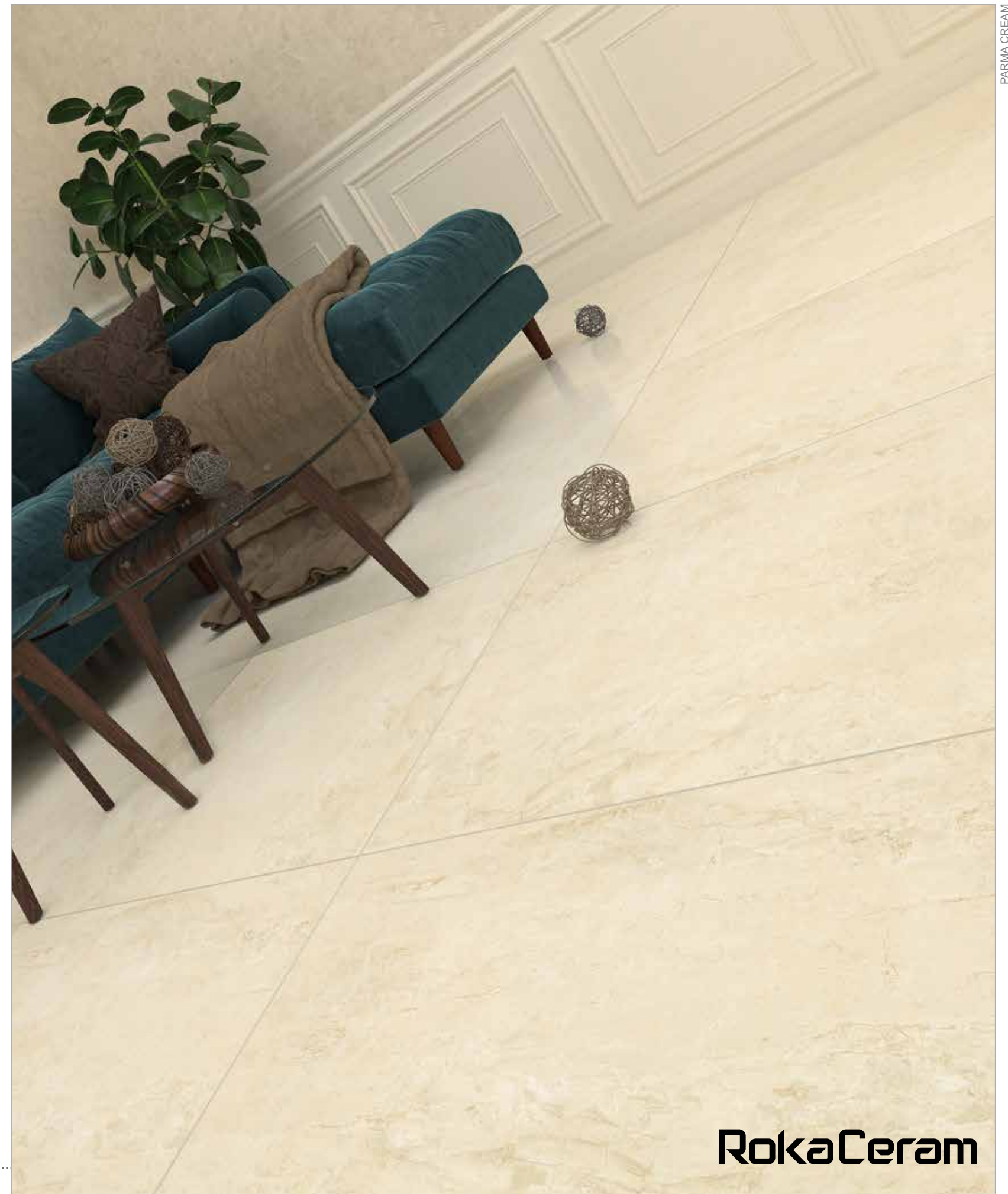

RokaCeram



PARMA CREAM

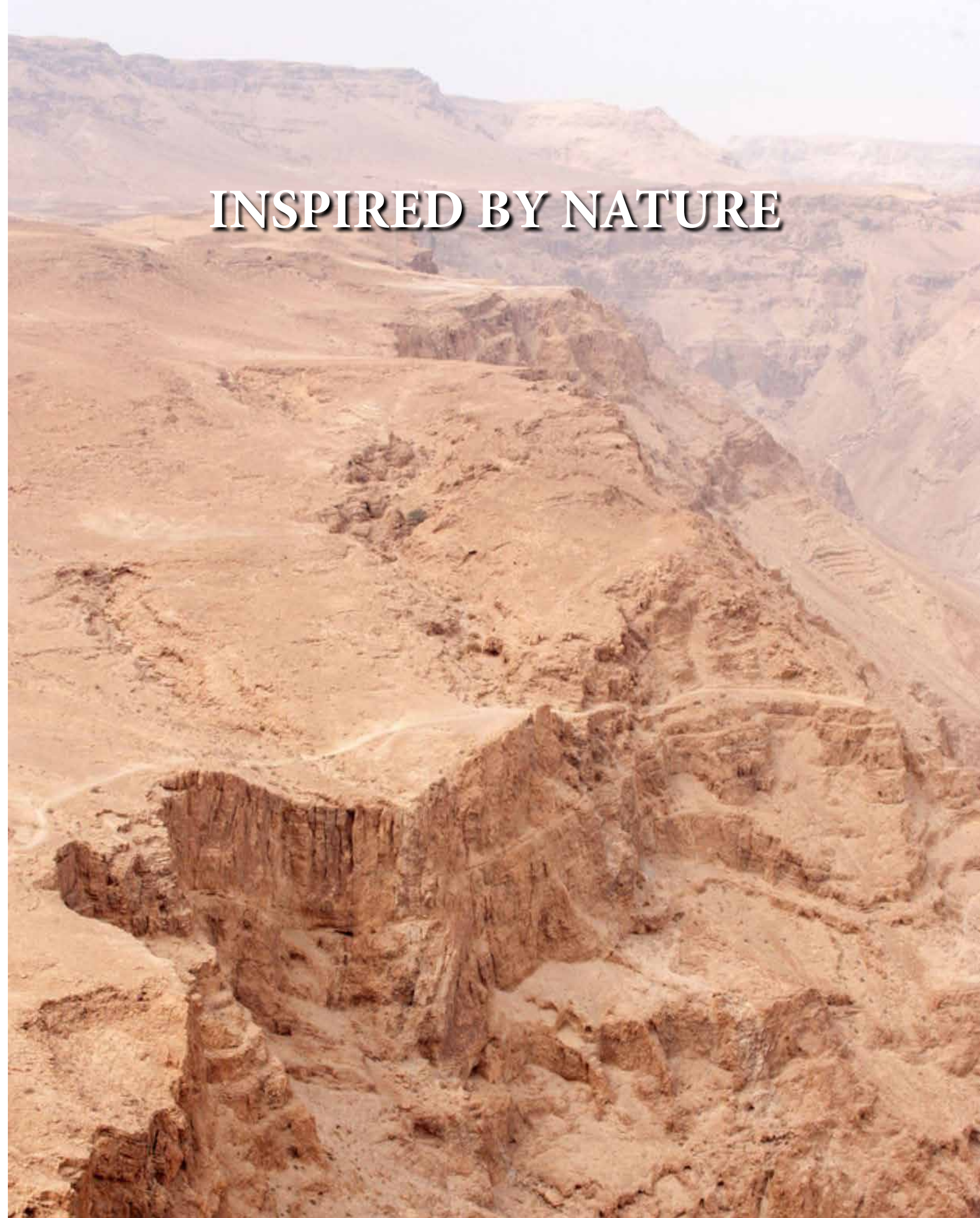

INSPIRED BY NATURE

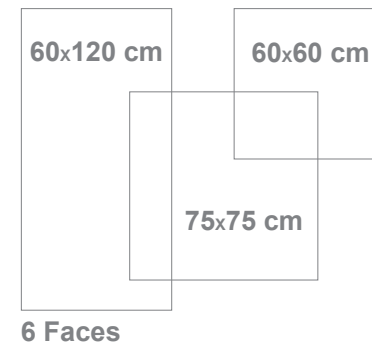

The moments are fleeting; at every step, something remains with you and something is added to you by the destiny, and if separated from you a bit, it will adorn the world in a different color so that the twists and turns of the life would take a different color and every day becomes unique.



Thanks to its native 1.1cm thickness, provides lightness and strength in all applications - even the ones you'd never even imagined.



Rokaceram offers unmatched project flexibility and the freedom to give concrete form to your ideas without being shackled by size.



RokaCeram

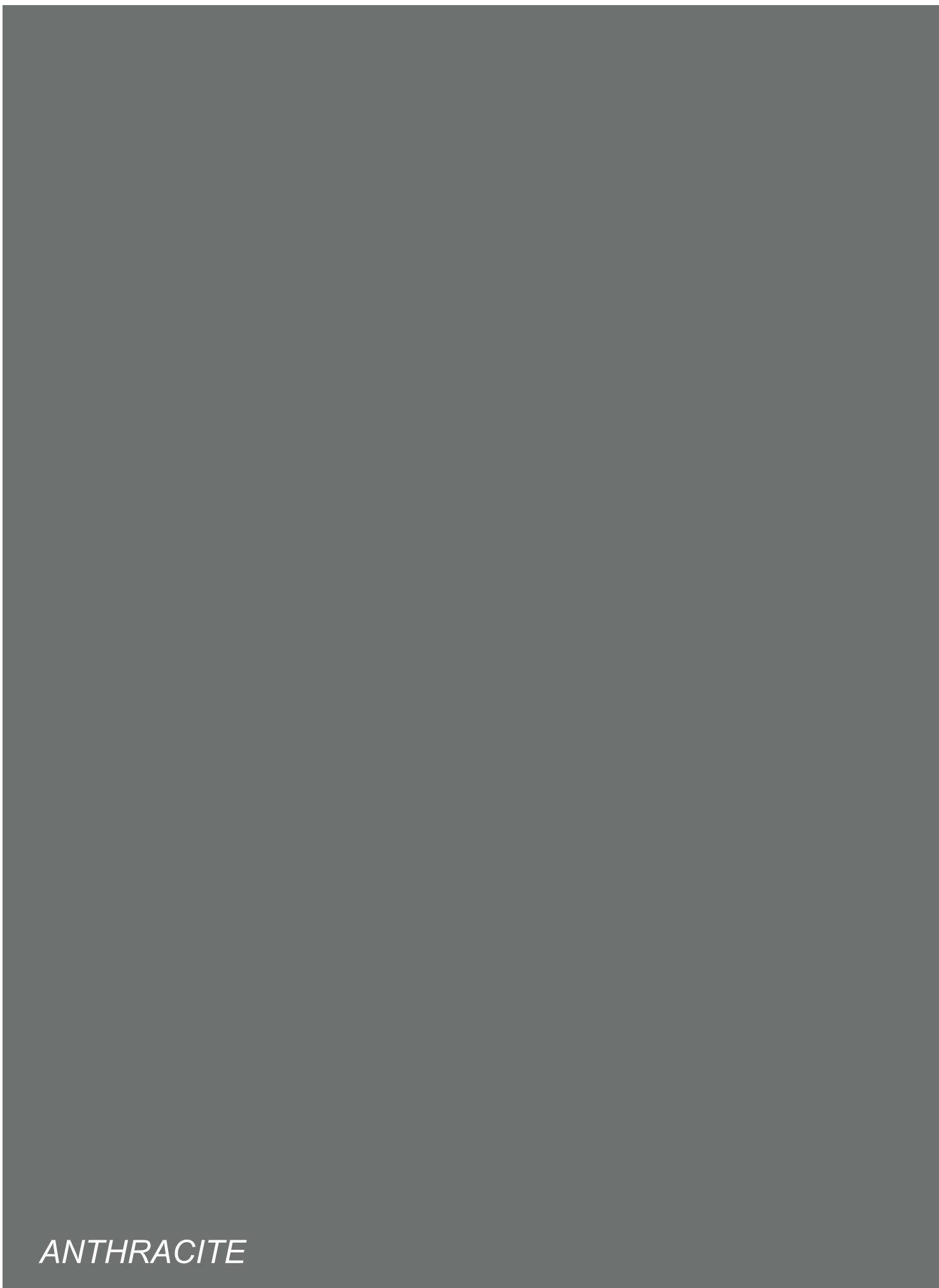

ANTHRACITE

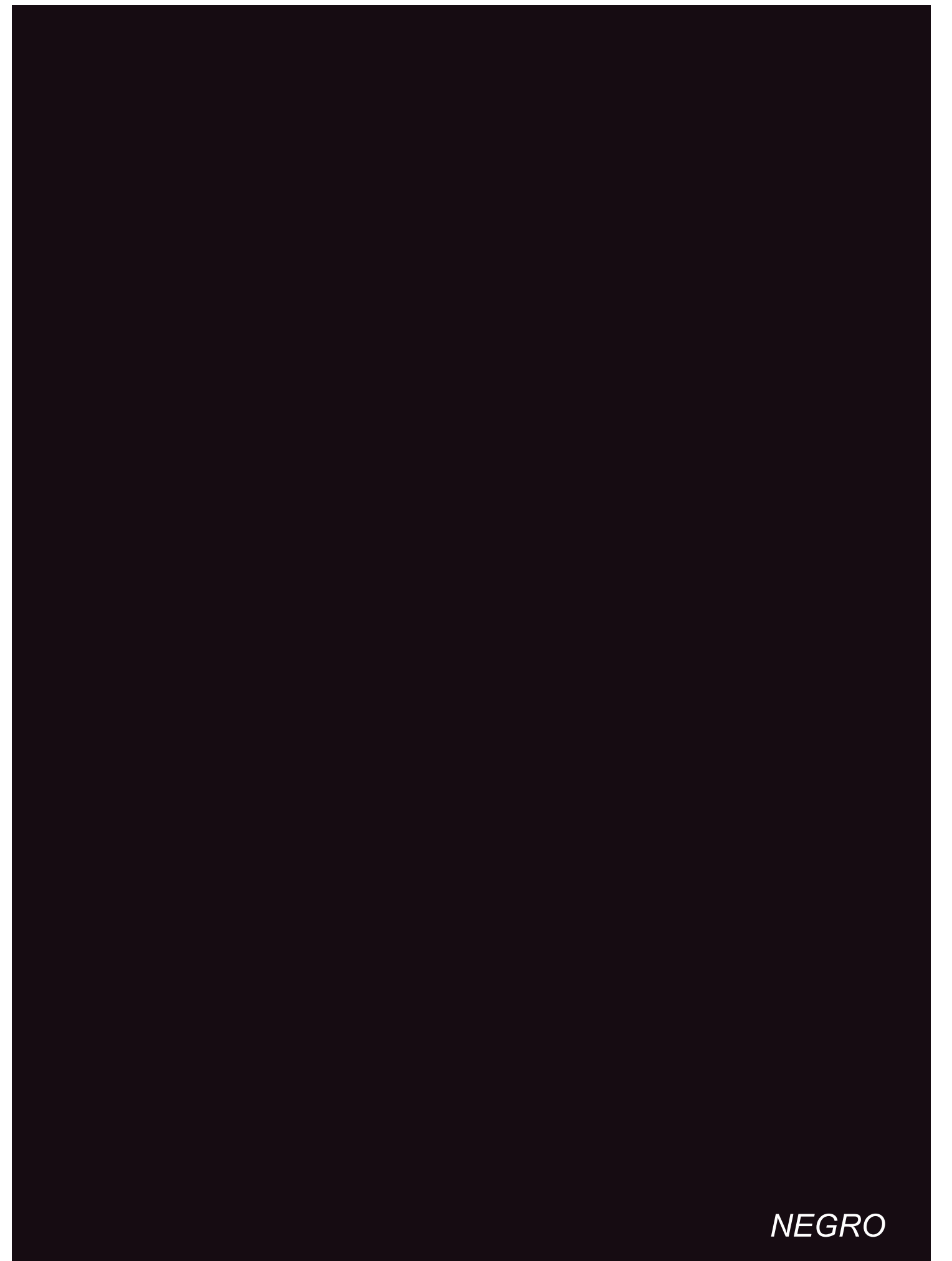

NEGRO

LIGHT GRAY

DARK GRAY

BLANCO

CREAM

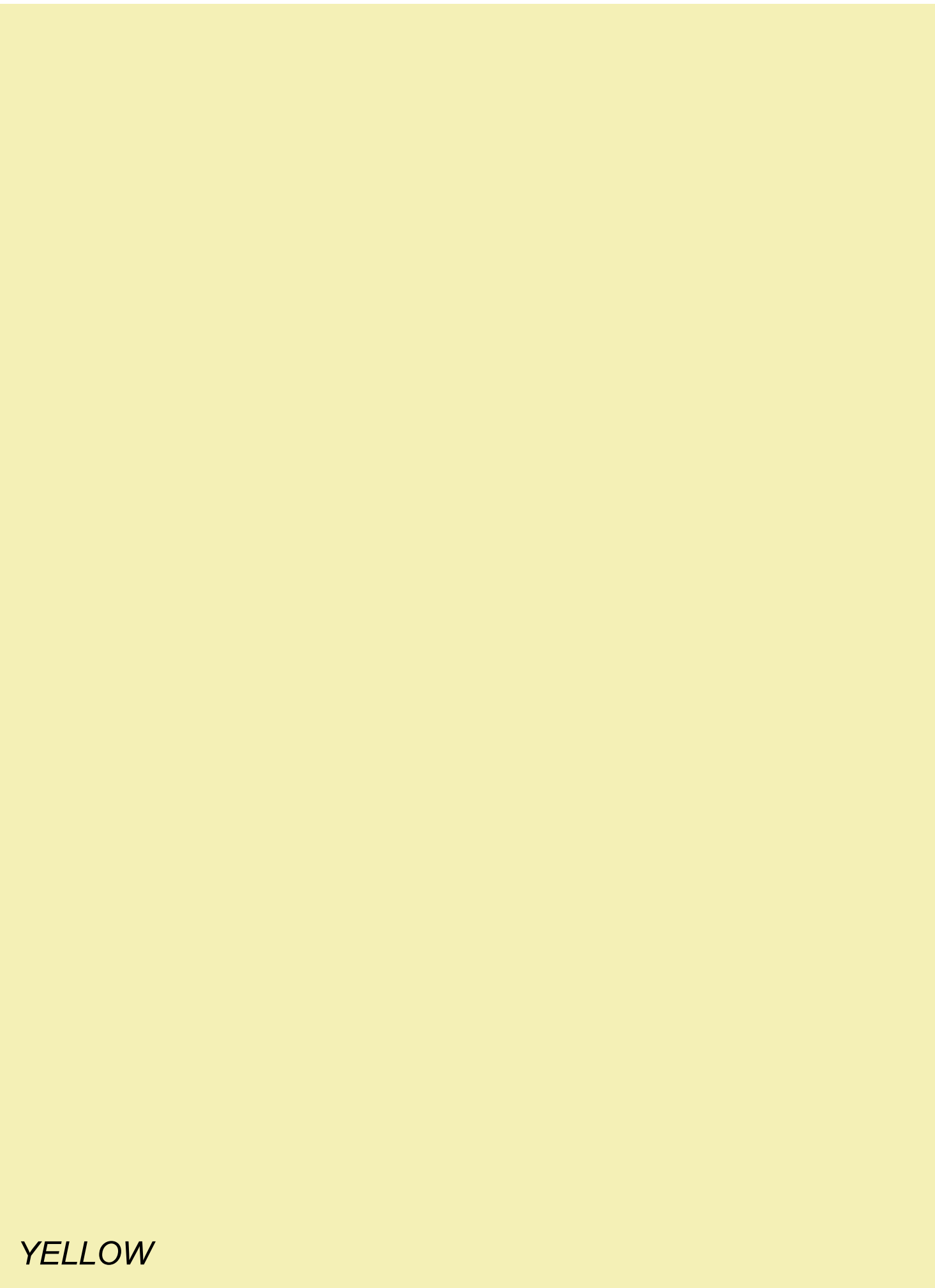

YELLOW

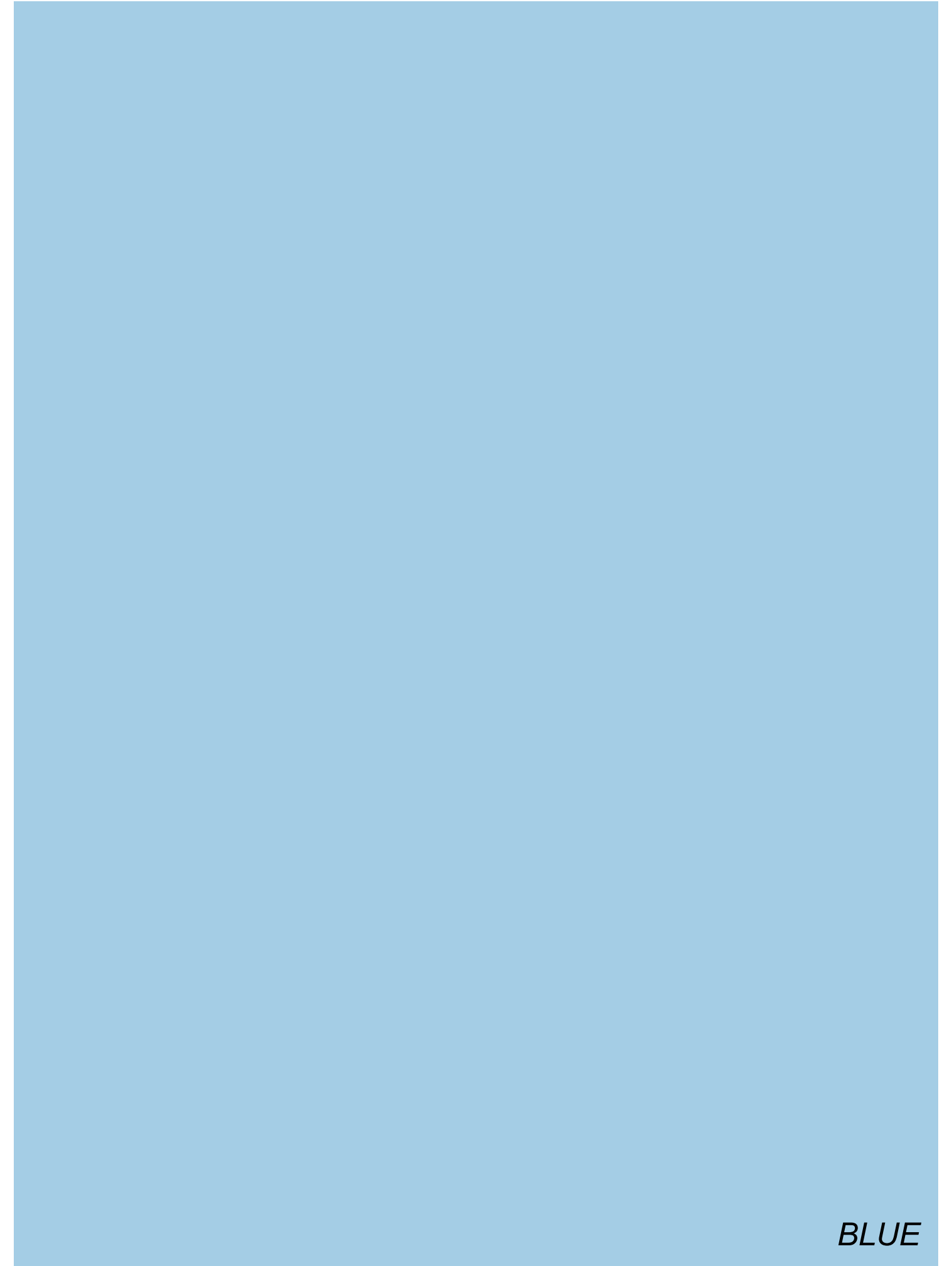

BLUE



DARK GREEN

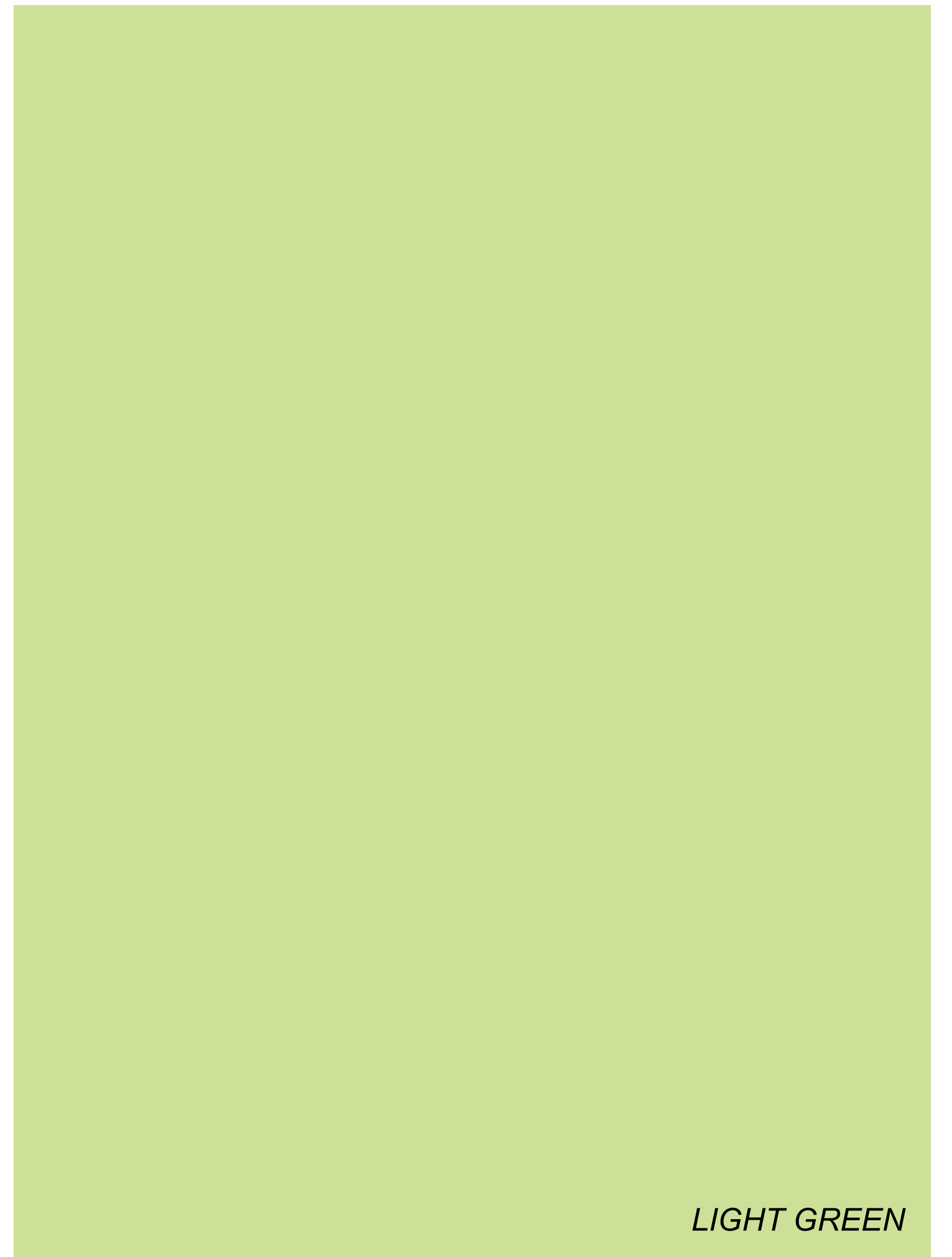

LIGHT GREEN



GREEN

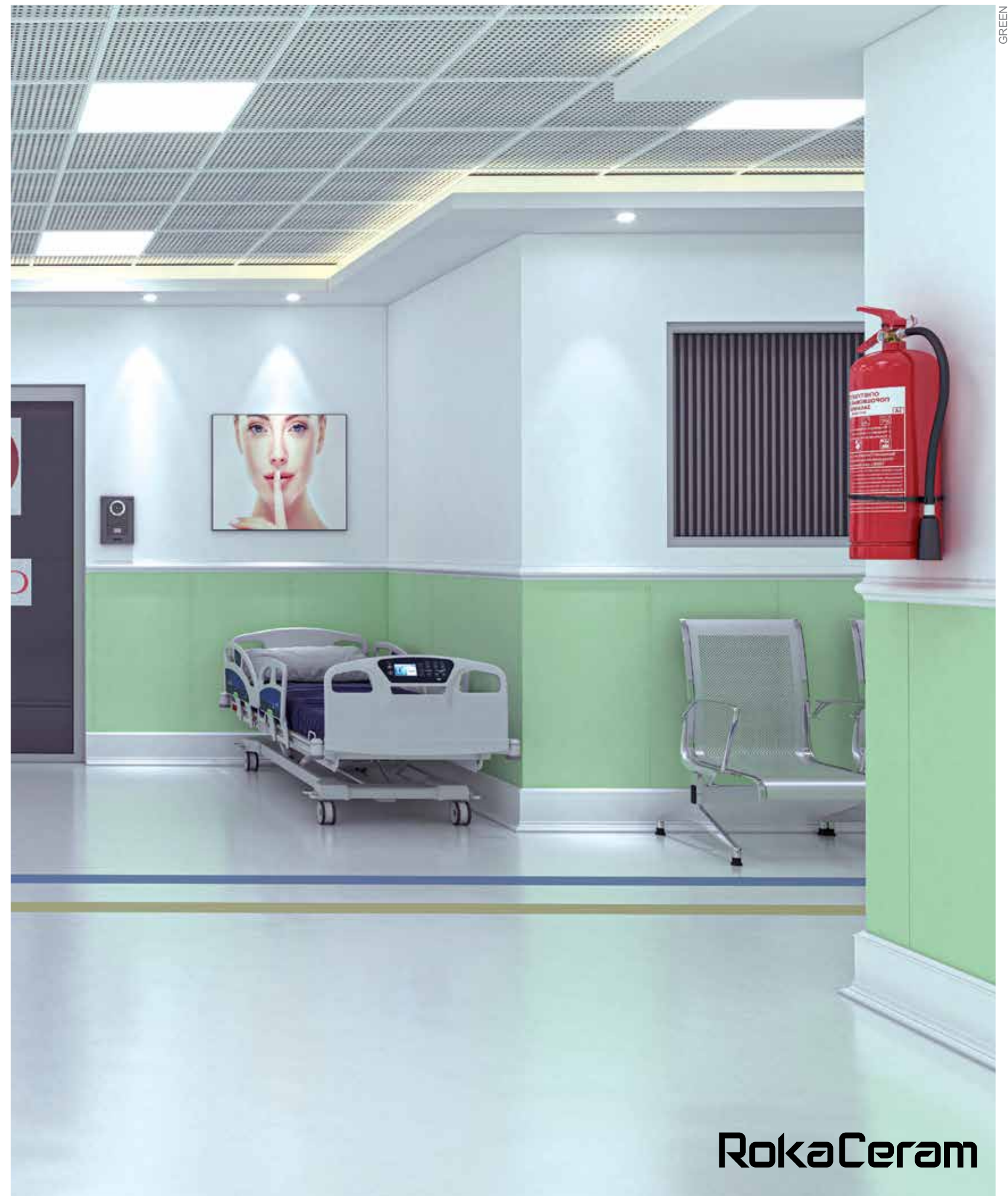

GREEN

RokaCeram

SUGAR COLLECTION

The special effects of sugar are prepared by mixing two types of imported granules mixed at a given ratio depending on the surface requirement and applied on the surface through a new technology.

Transforming the entire look of a place is not that easy a task but it can be made easier by choosing the right tiles for the place. Sugar finish tiles can be the best choice if you're looking for some really high class and suave ones. These tiles have a unique grainy surface that makes them the most attractive thing in a room once you lay them down. Moreover, these tiles are resistant to stains and scratches so they don't even absorb moisture. These tiles have the ability to withstand heavy foot traffic and can even bear any kind of wear and tear. Not only this, these tiles have anti-skid properties which makes them less slippery and safe for houses where old aged people and children are living. These sugar finish floor tiles are an ideal choice for all kinds of places such as living rooms, swimming pools decks, porches, bedrooms, offices, bathrooms, backyards etc. Secondly, these tiles are made up of porcelain or vitrified body thus be assured that they are one of the most durable tiles available at **RokaCeram**.

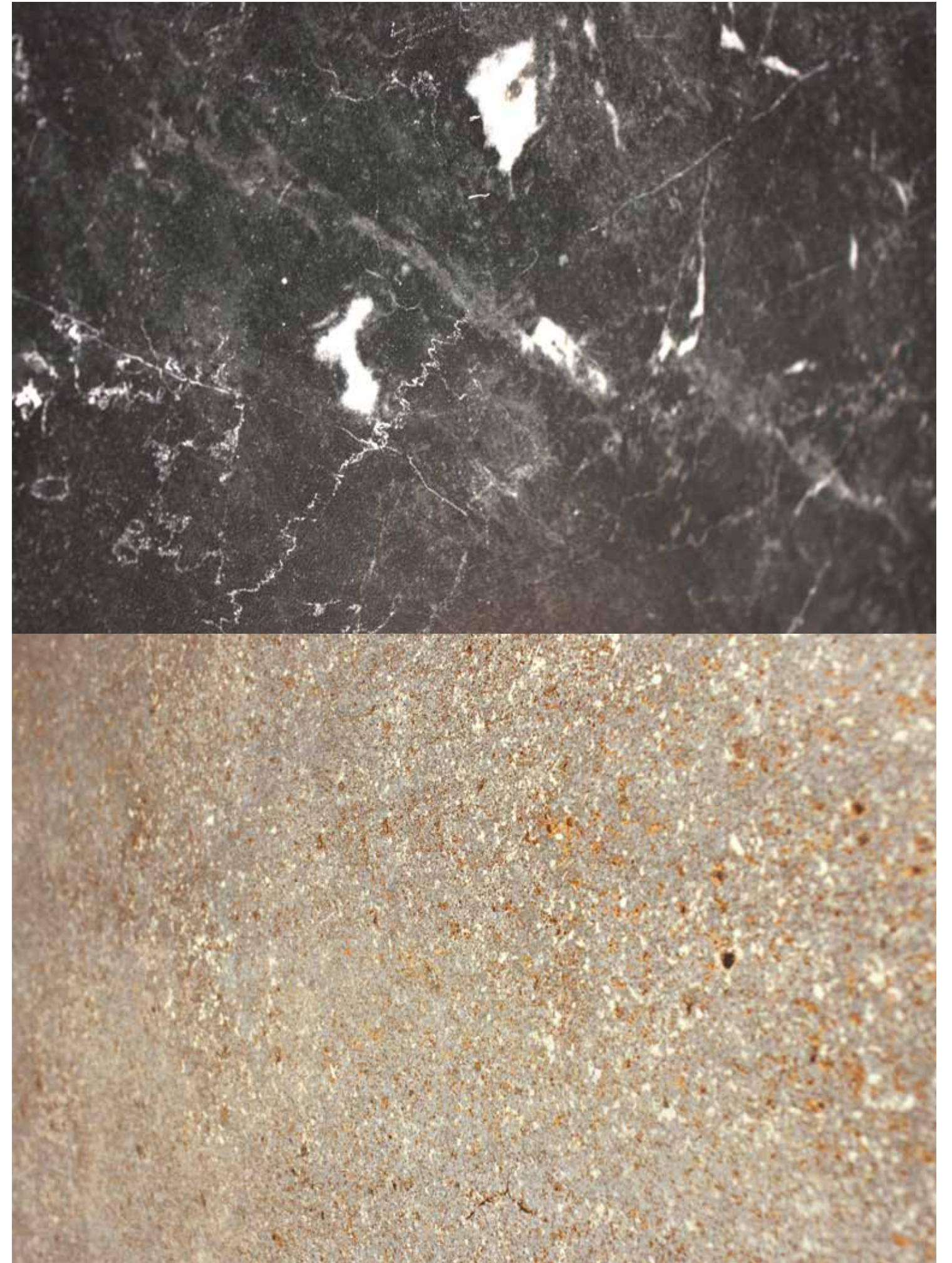

SUGAR COLLECTION

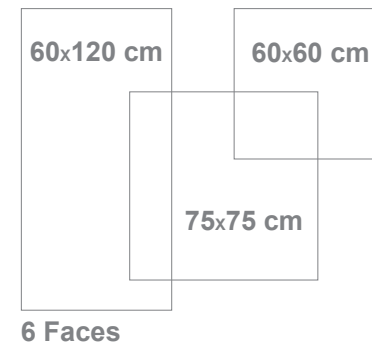

You stand in front, when staring at you in the mirror to be relieved of any opacity, you hammer and shatter the mirror and restart building, living and loving. Baron is your savior of a hazy, misty world.



Thanks to its native 1.1cm thickness, provides lightness and strength in all applications - even the ones you'd never even imagined.



Rokaceram offers unmatched project flexibility and the freedom to give concrete form to your ideas without being shackled by size.

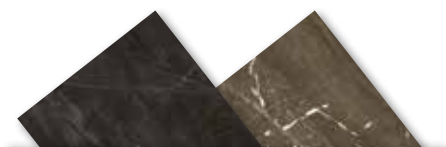

RokaCeram



BARON BROWN

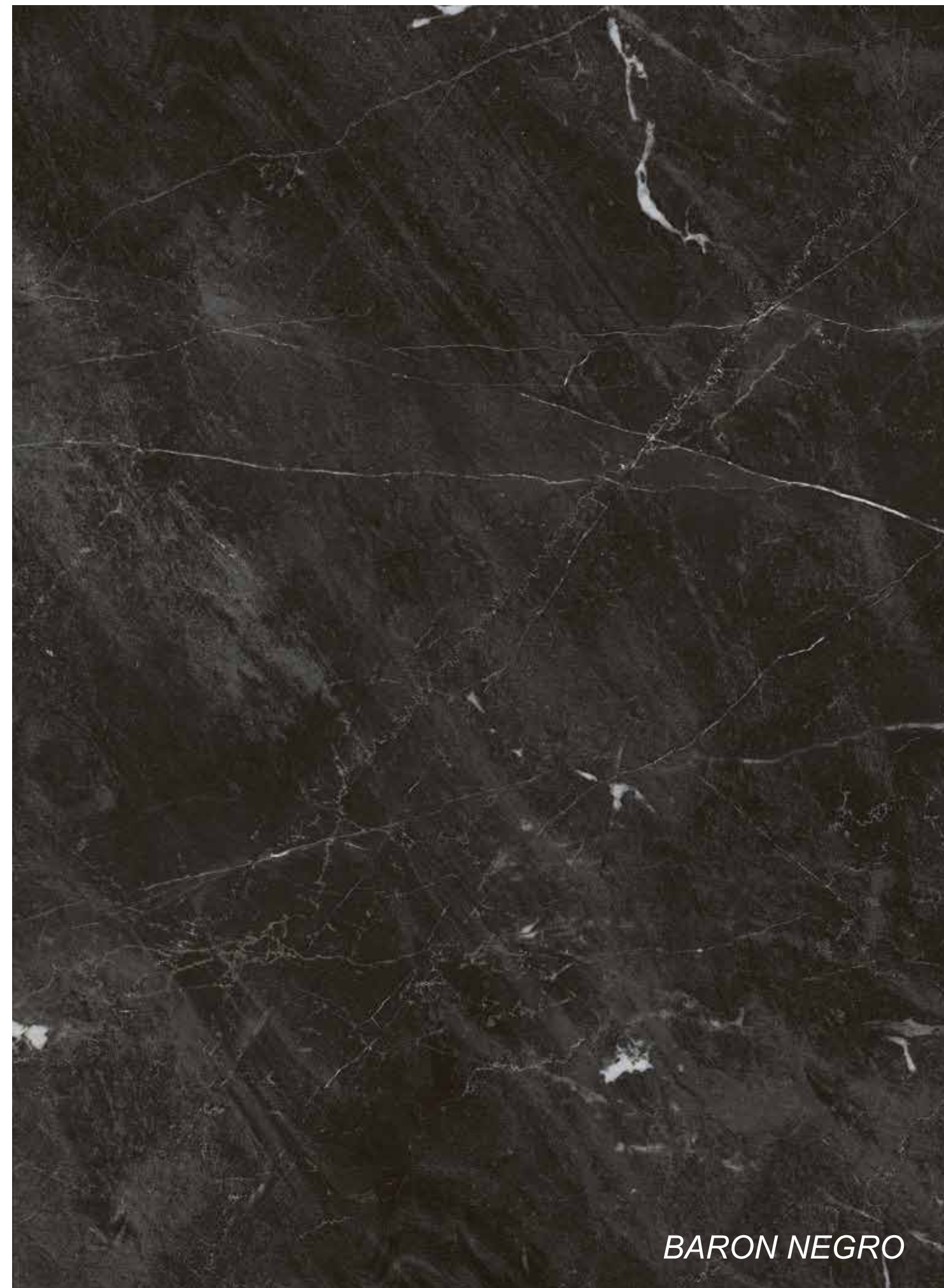

BARON NEGRO

SUGAR COLLECTION

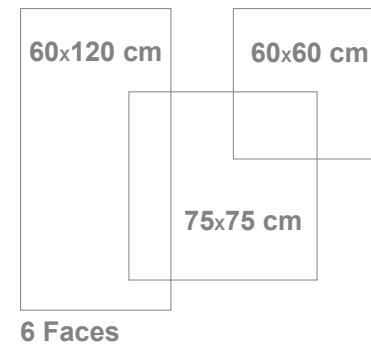

It breaks the color into parts and creates the dots which are neither fully attached nor entirely detached. It undergoes a variation, at times gray, at times beige, at times gold.



Thanks to its native 1.1cm thickness, provides lightness and strength in all applications - even the ones you'd never even imagined.



Rokaceram offers unmatched project flexibility and the freedom to give concrete form to your ideas without being shackled by size.

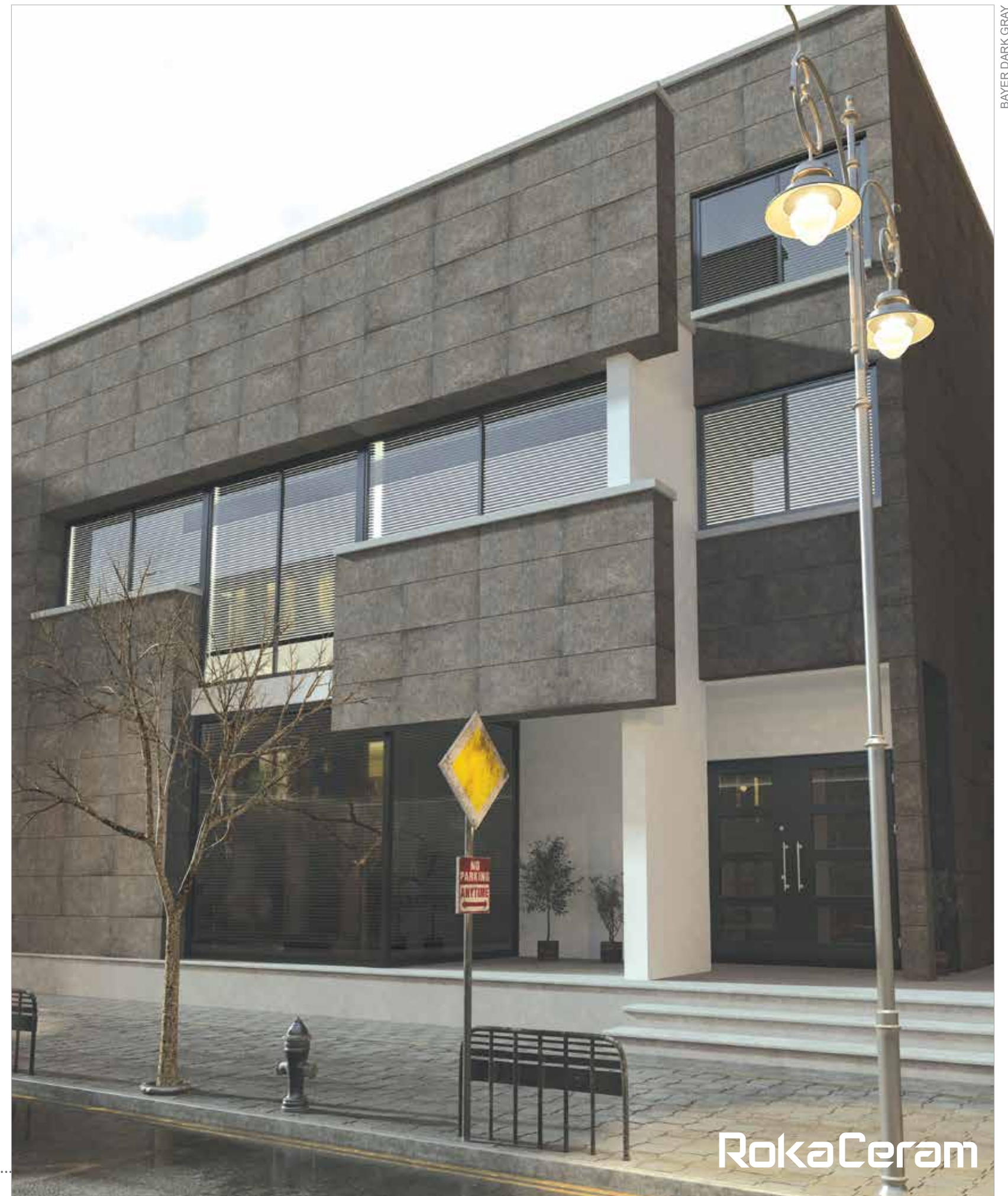
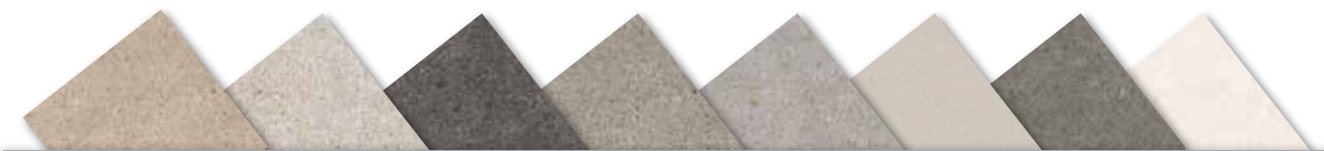

RokaCeram



BAYER BLUEGOLD



BAYER DARK GRAY



BAYER LIGHT GRAY



BAYER TORQUISE



BAYER BIEGE

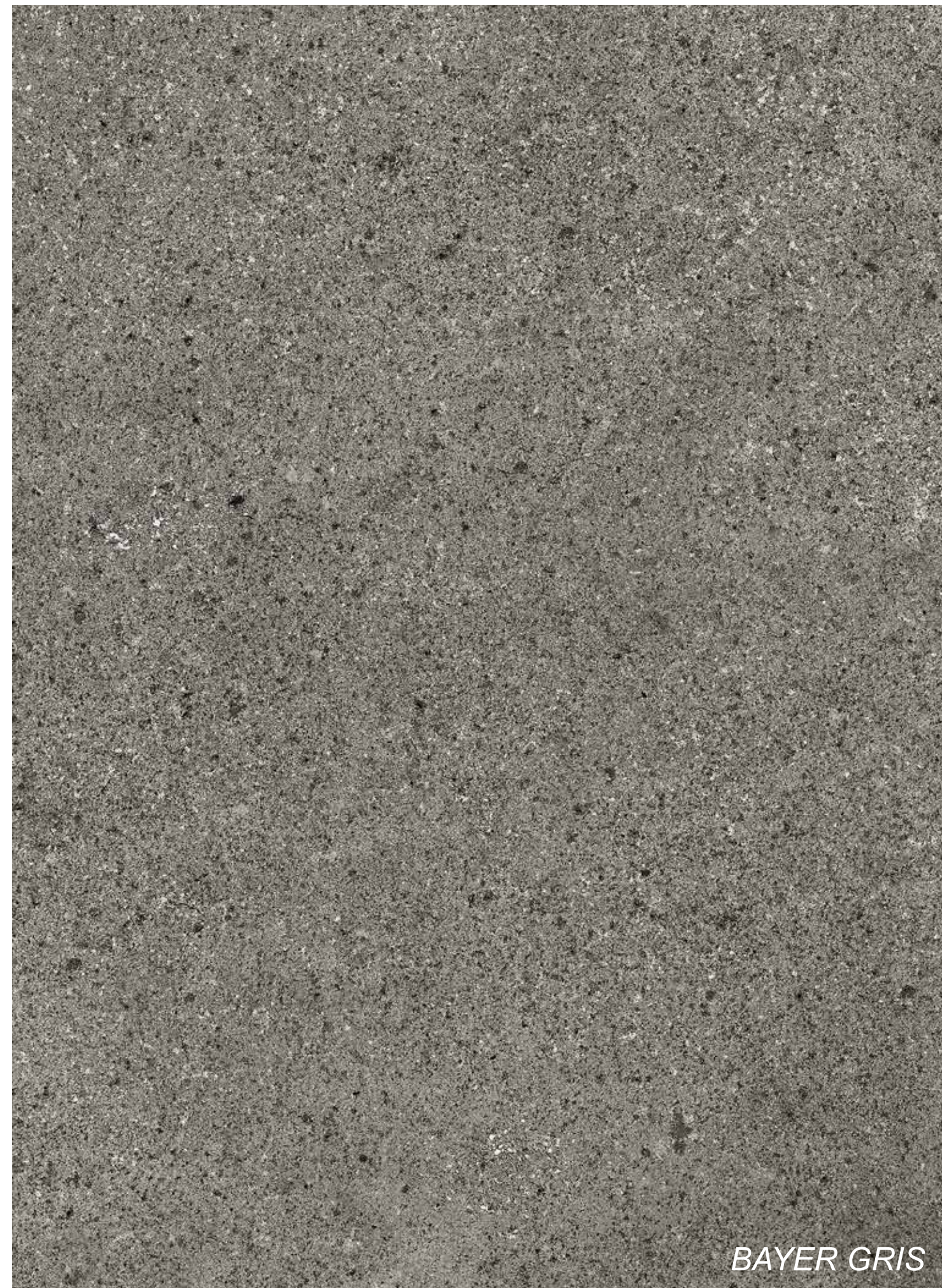

BAYER GRIS



BAYER GRAY



BAYER WHITE

SUGAR COLLECTION

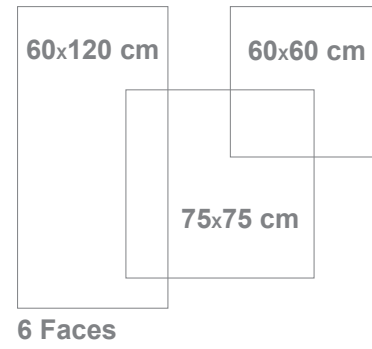

The branches are intertwined so that you can't see but the leaves, no trace of a branch or even a trunk. It is as if you were flying over the forest and you were enjoying the density and the beauty.

 SPORT CENTER	 HEADQUARTER	 RESTAURANT	 HOTEL	 VENTILATED FACADES
 HOME	 SHOP	 HOSPITAL	 AIRPORT	 OFFICE
 FROST RESISTANCE	 RESIDENTIAL USE	 FLOOR TILES	 LIGHT COMMERCIAL	 WALL TILES



Thanks to its native 1.1cm thickness, provides lightness and strength in all applications - even the ones you'd never even imagined.



Rokaceram offers unmatched project flexibility and the freedom to give concrete form to your ideas without being shackled by size.

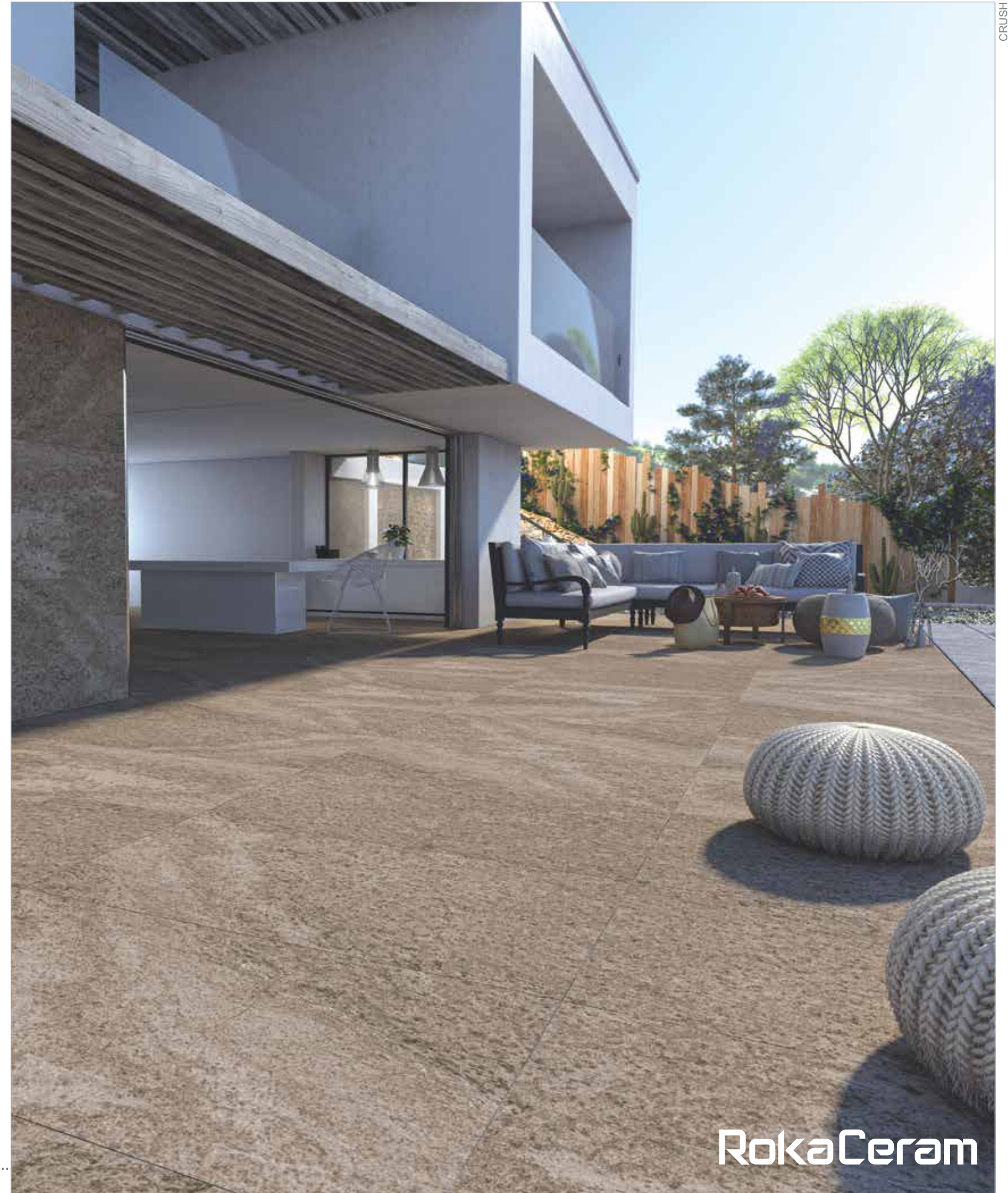

RokaCeram



CRUSH

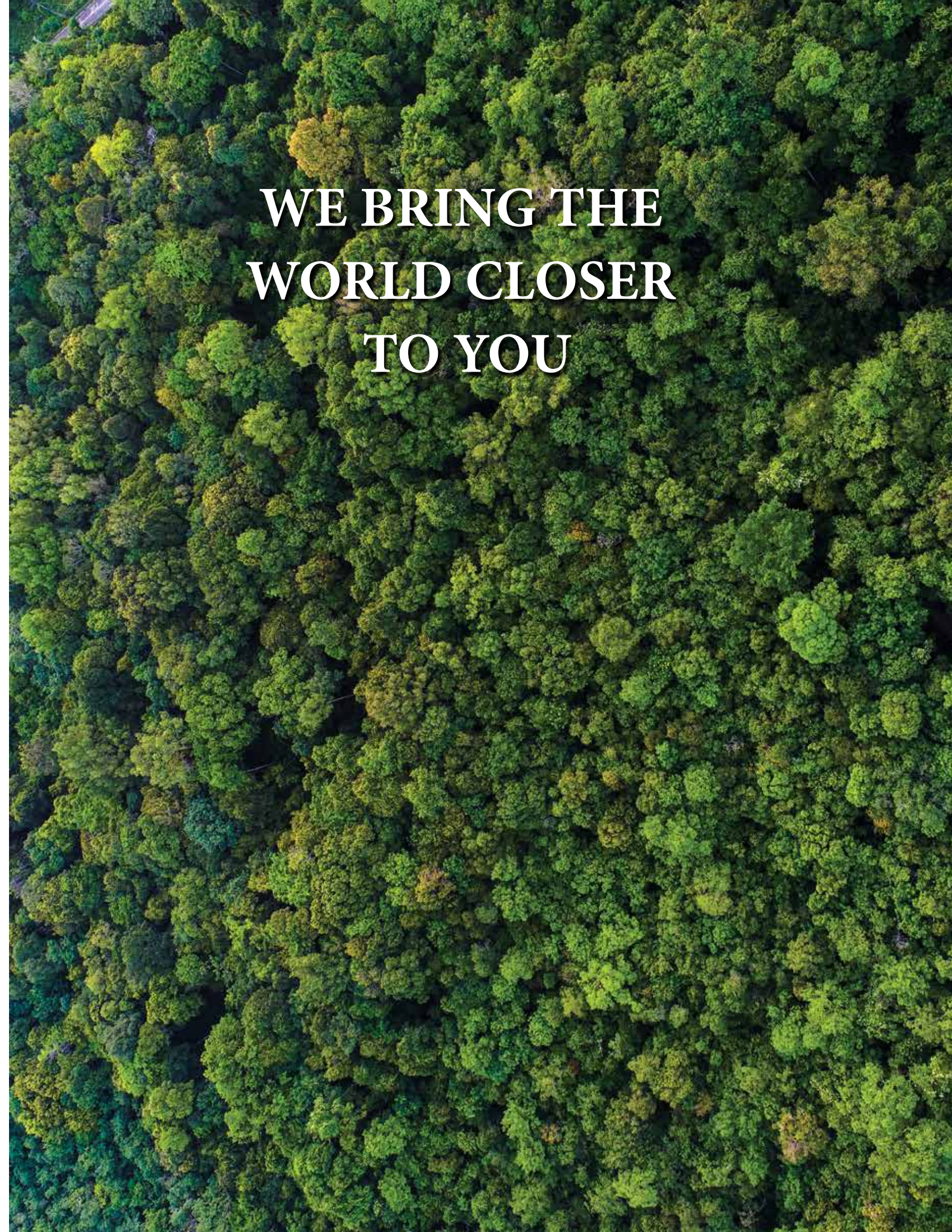

**WE BRING THE
WORLD CLOSER
TO YOU**

SUGAR COLLECTION

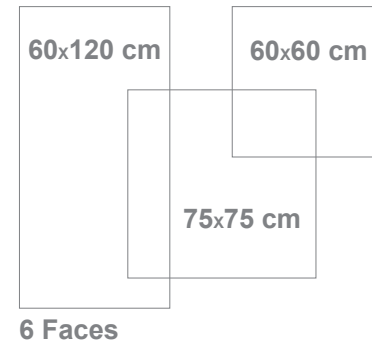

A design of delicacy, from the distance solely offering your eyes simplicity and tranquility yet when looking at it closely, it is all pictures and prints and concepts leading your heart to one world and your mind to another.



Thanks to its native 1.1cm thickness, provides lightness and strength in all applications - even the ones you'd never even imagined.



Rokaceram offers unmatched project flexibility and the freedom to give concrete form to your ideas without being shackled by size.

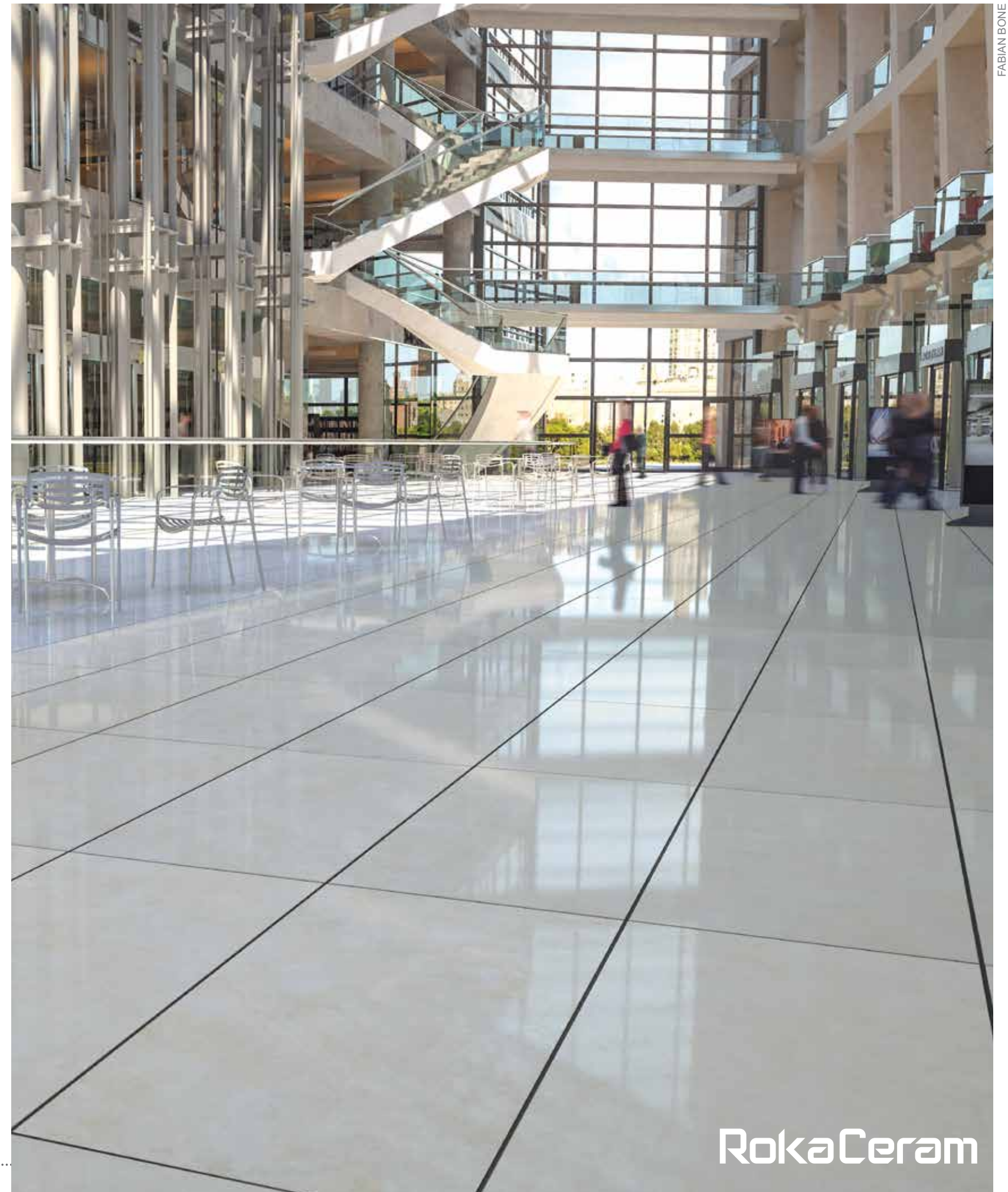

RokaCeram



FABIAN BIEGE



FABIAN BONE

SUGAR COLLECTION

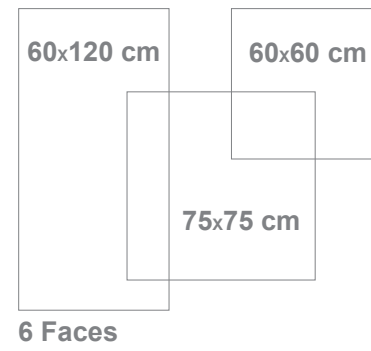

A composition as warm as the sun and as hot as a desert's sands slowly flowing in all directions led by the wind, creating lines which never reach as far as the eyes are set on.



Thanks to its native 1.1cm thickness, provides lightness and strength in all applications - even the ones you'd never even imagined.



Rokaceram offers unmatched project flexibility and the freedom to give concrete form to your ideas without being shackled by size.

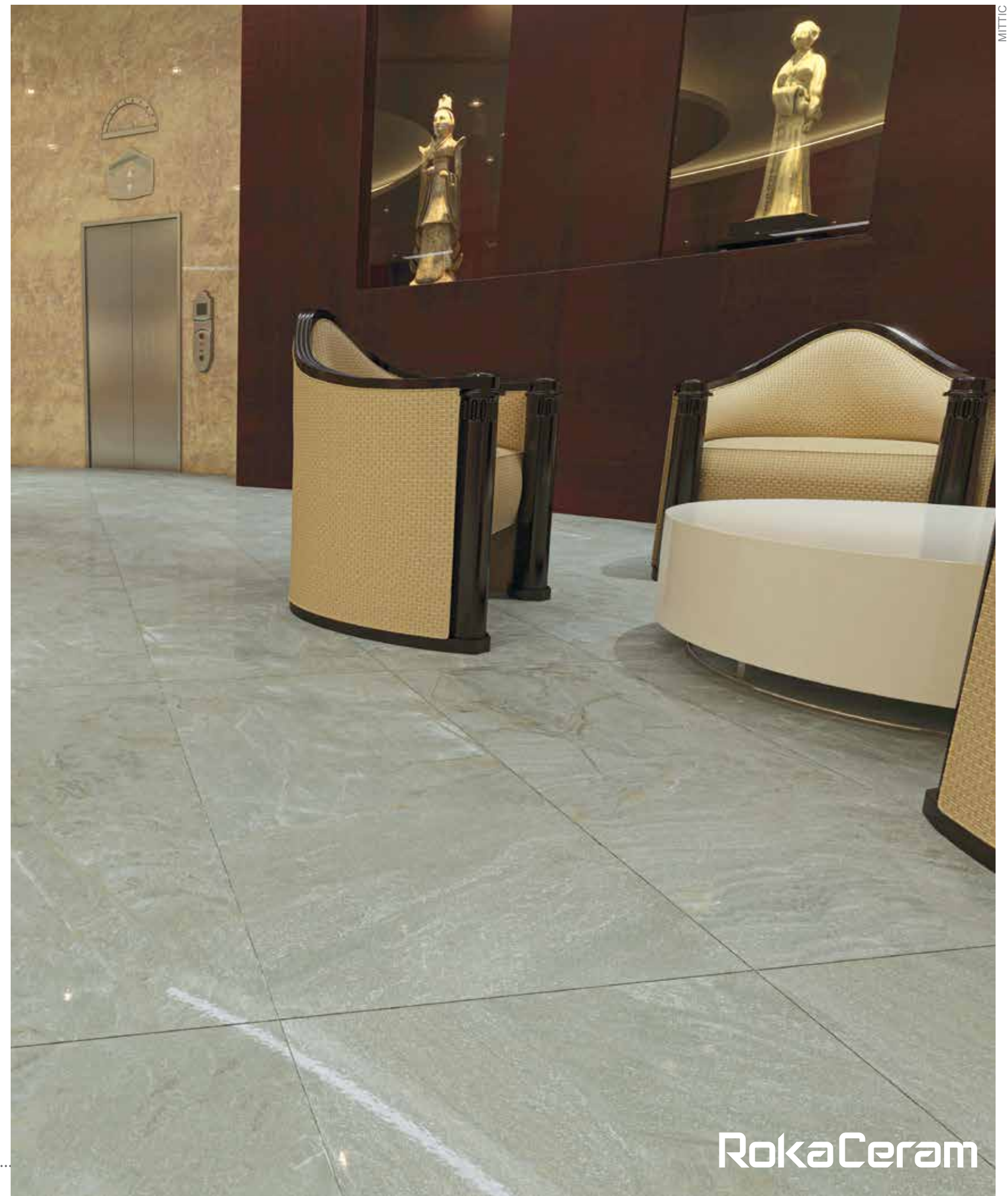
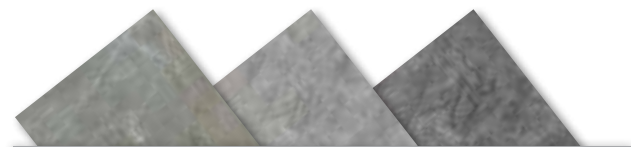

RokaCeram



MITTIC DARK GRIS



MITTIC LIGHT GRIS



MITTIC

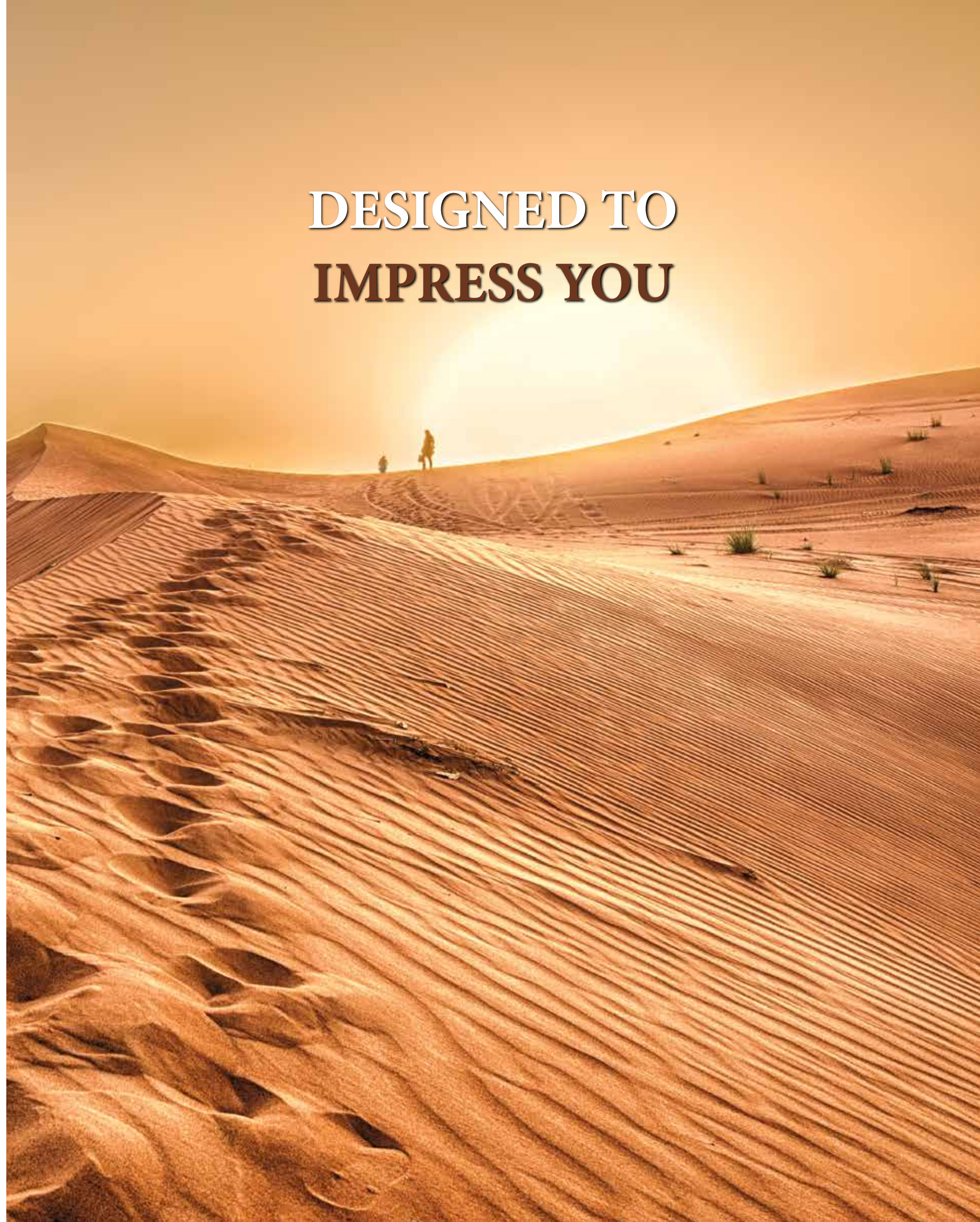

DESIGNED TO
IMPRESS YOU

SUGAR COLLECTION

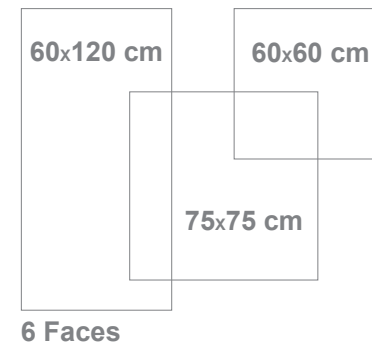

like flood, it falls down and creates the path. Paths as much as beautiful, eye-catching and warm as a volcano. Stare Sail and enjoy its colors and lines.



Thanks to its native 1.1cm thickness, provides lightness and strength in all applications - even the ones you'd never even imagined.



Rokaceram offers unmatched project flexibility and the freedom to give concrete form to your ideas without being shackled by size.



RokaCeram



SAIL

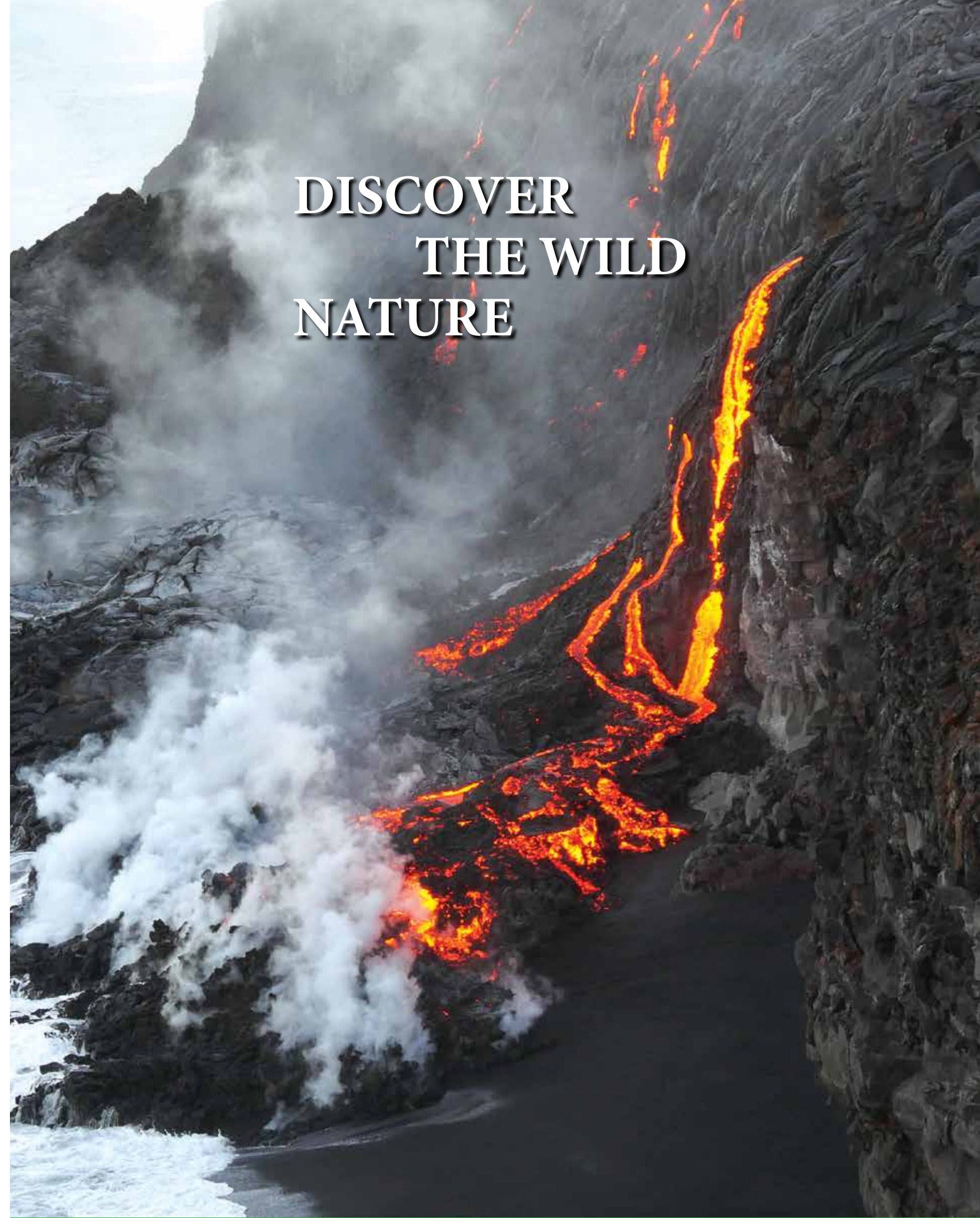

DISCOVER
THE WILD
NATURE

CARVING COLLECTION

If you're wondering how to turn your space into a modern luxurious look with tiles, then Carving Effect is one the best choice for it. Carving effect not only provides a depth effect to your flooring but also adds a shining effect. RokaCeram offers a variety of best Carving Effect tiles options to enhance your interior look. The carving Effect holds the essence of nature with natural stone design and gives a positive outlook to your space. Check out the wide range of Carving Effect Tiles Designs offered by RokaCeram that is currently making a remarkable impact in the market.

Today Carving effect in flooring is highly appreciated at offices, restaurants, airports, shopping centers, schools, and more. They are stylish plus durable. Apart from design and colour, what makes the carving effect more attractive is its resistance to stains, scratches and easy to maintain. The simple and sophisticated look will make you want to spend more time in your house and bring in a sense of calm into your life.

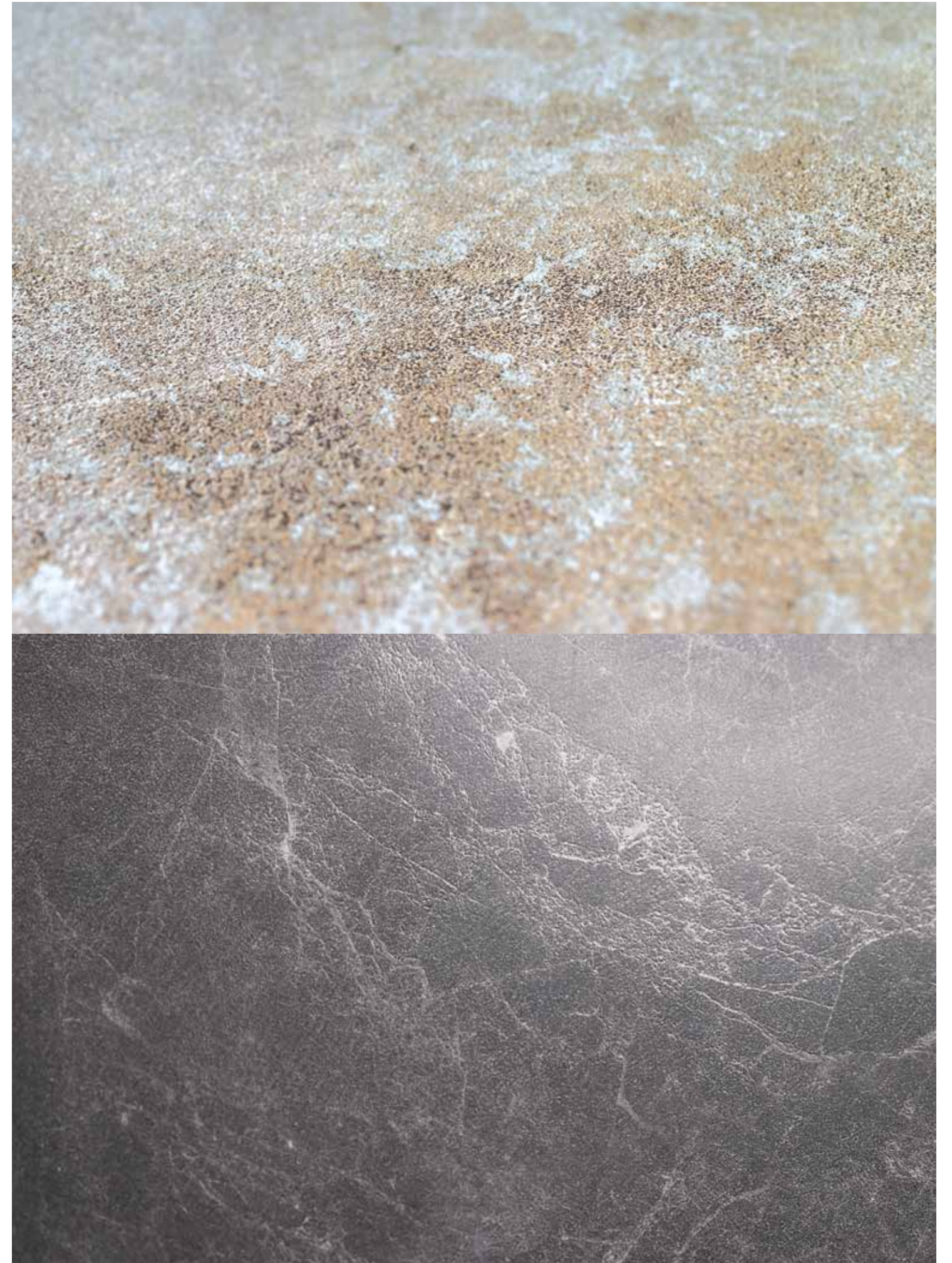

CARVING COLLECTION

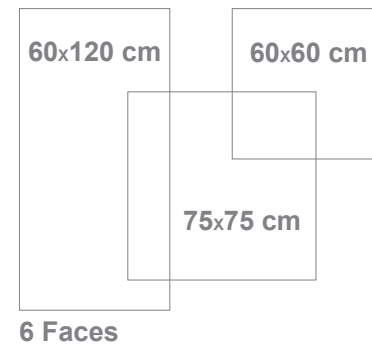

Turin takes its roots from the fountain, boiling and falling, creating a mirror of nature and beauty upon each roll.



Thanks to its native 1.1cm thickness, provides lightness and strength in all applications - even the ones you'd never even imagined.



Rokaceram offers unmatched project flexibility and the freedom to give concrete form to your ideas without being shackled by size.



RokaCeram



TURIN BROWN



TURIN NESCAFE

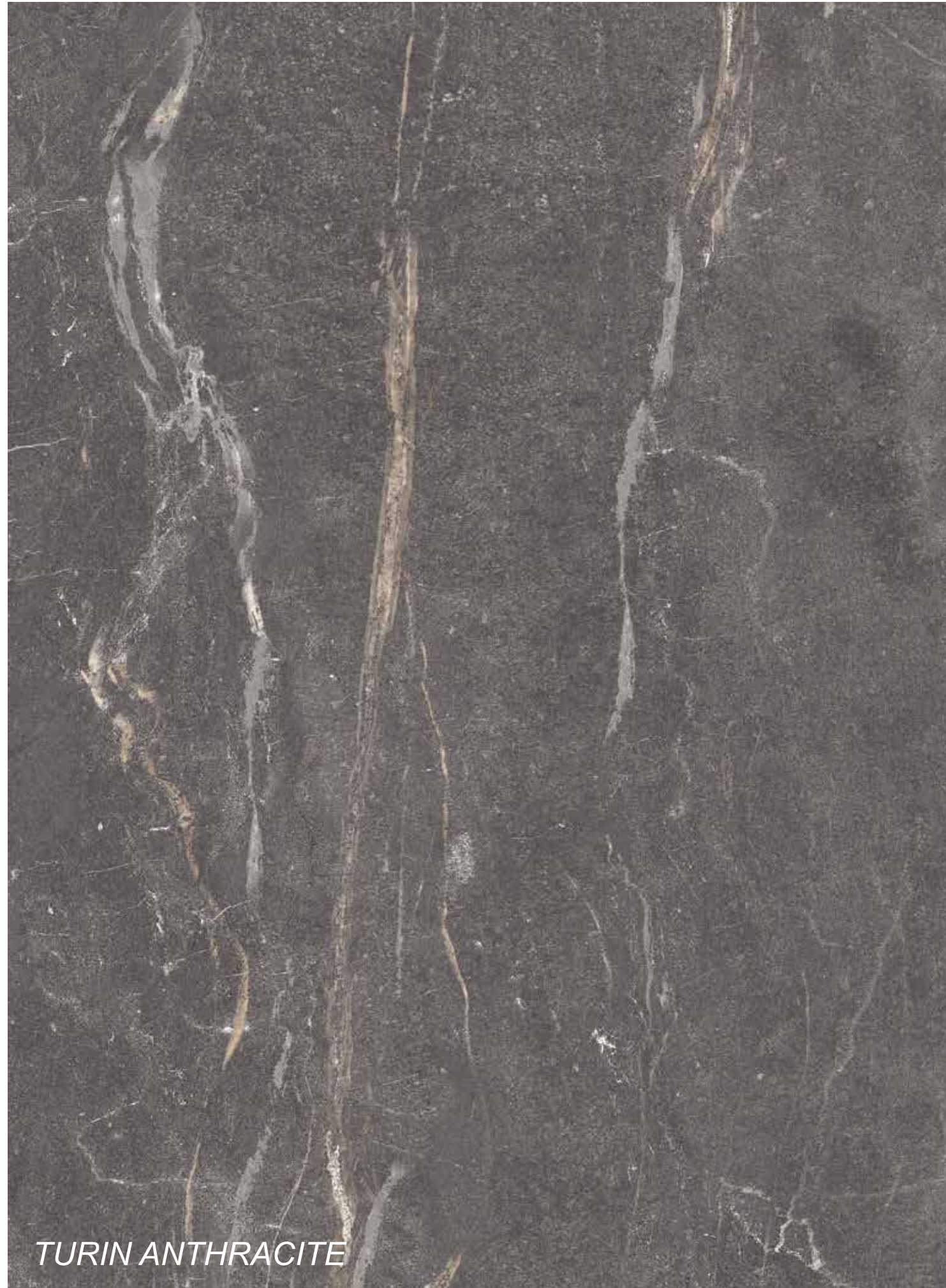

TURIN ANTHRACITE

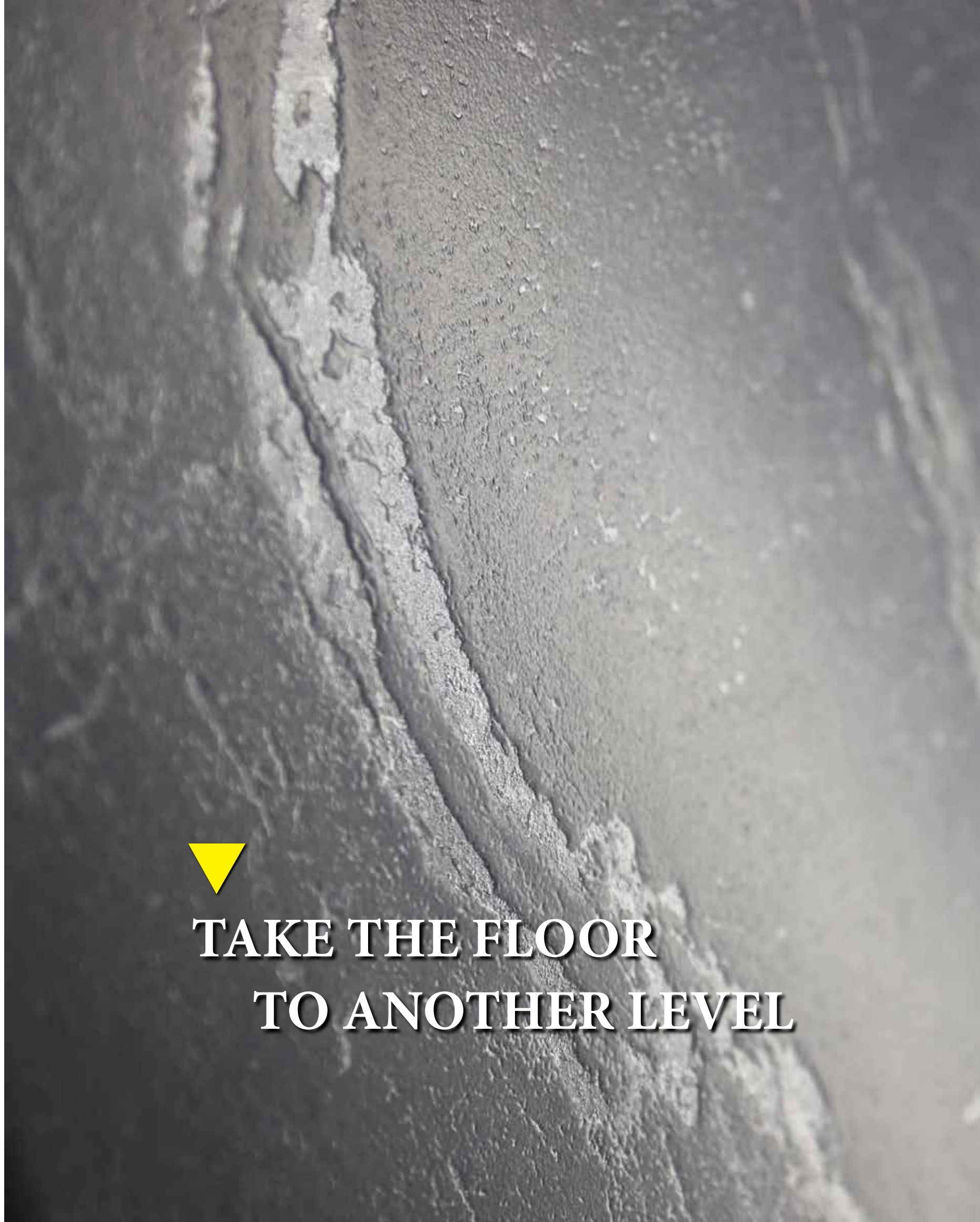

TAKE THE FLOOR
TO ANOTHER LEVEL

CARVING COLLECTION

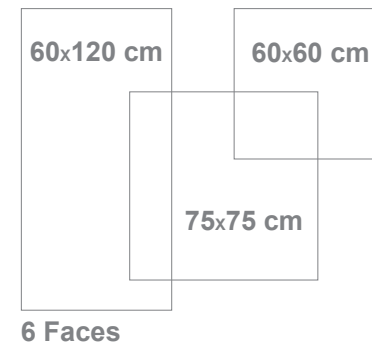

When there is a fault line on the heart, the roots go beyond the galaxy, and so does the fault falling on the ground. Roots are plotted on the soil and the picture is created. Coco has a fault that is the axis of the terrestrial capillaries.



Thanks to its native 1.1cm thickness, provides lightness and strength in all applications - even the ones you'd never even imagined.



Rokaceram offers unmatched project flexibility and the freedom to give concrete form to your ideas without being shackled by size.

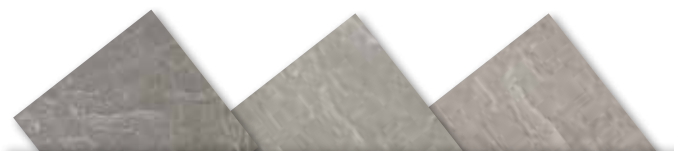

RokaCeram

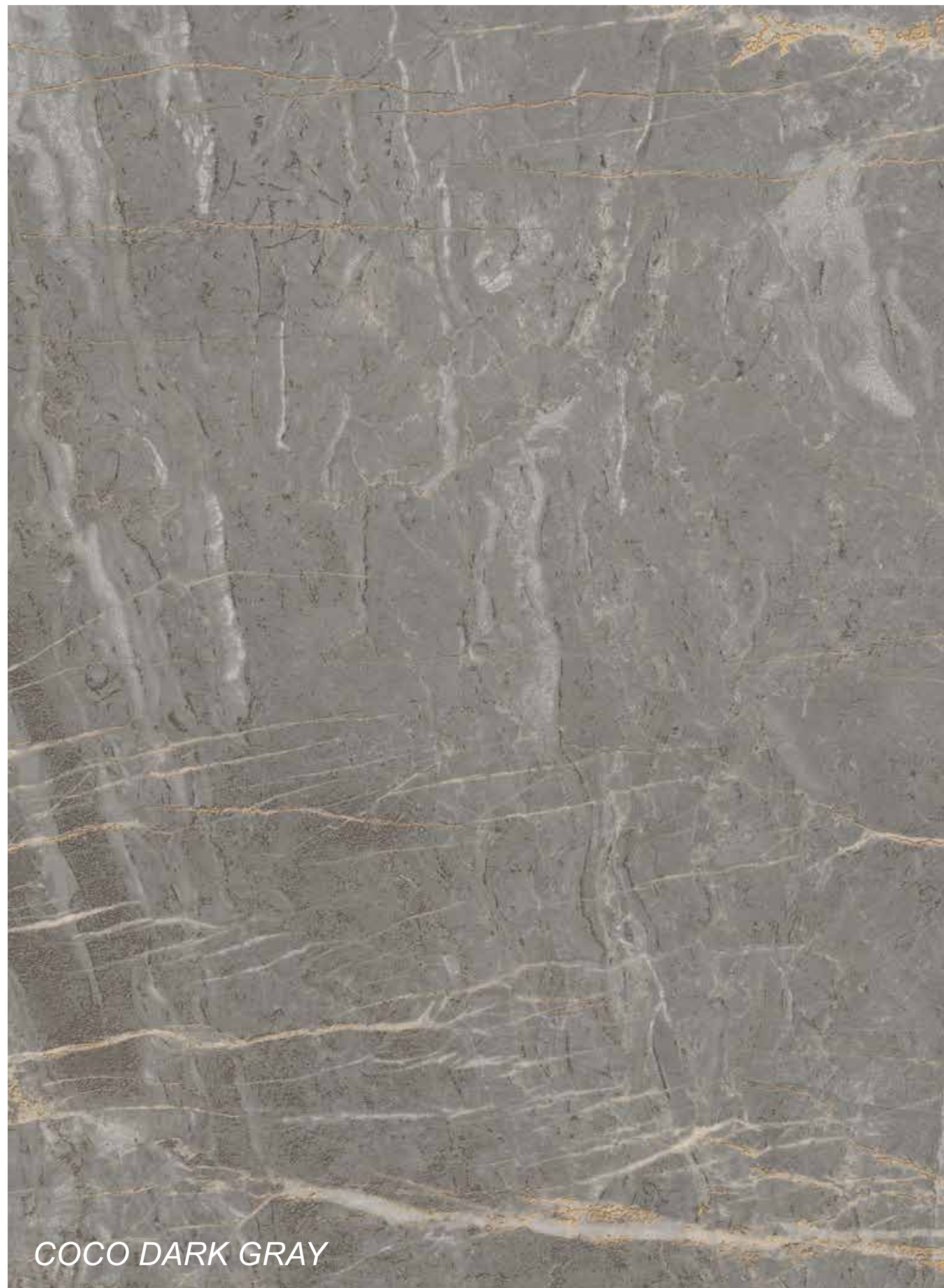

COCO DARK GRAY



COCO OLIVE



COCO LIGHT GRAY

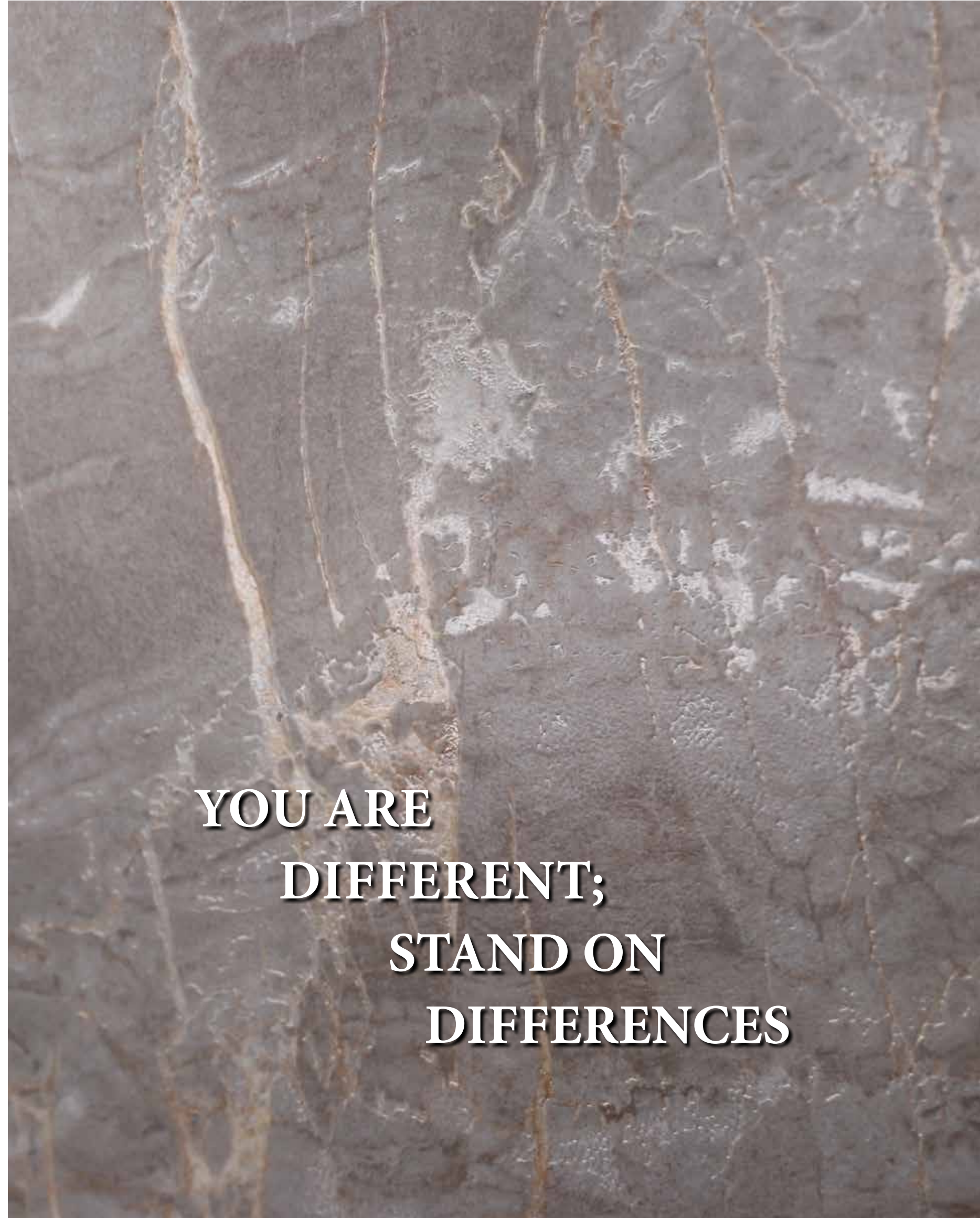

**YOU ARE
DIFFERENT;
STAND ON
DIFFERENCES**

CARVING COLLECTION

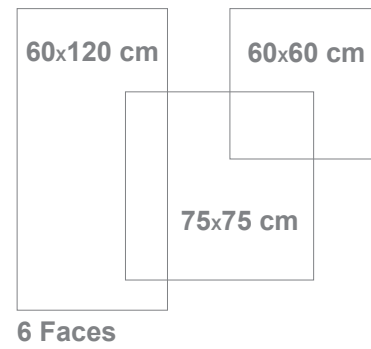

A bunch full of colors, while in contrast to each other, they are fully blended, creating a novel, homogeneous, and harmonious masterpiece staring at which relieves you from the cold of the Winter leading you to the warmth of the Summer, and at times taking you to the fallen leaves of the Autumn.

 SPORT CENTER	 HEADQUARTER	 RESTAURANT	 HOTEL	 VENTILATED FACADES
 HOME	 SHOP	 HOSPITAL	 AIRPORT	 OFFICE
 FROST RESISTANCE	 RESIDENTIAL USE	 FLOOR TILES	 LIGHT COMMERCIAL	 WALL TILES



Thanks to its native 1.1cm thickness, provides lightness and strength in all applications - even the ones you'd never even imagined.



Rokaceram offers unmatched project flexibility and the freedom to give concrete form to your ideas without being shackled by size.

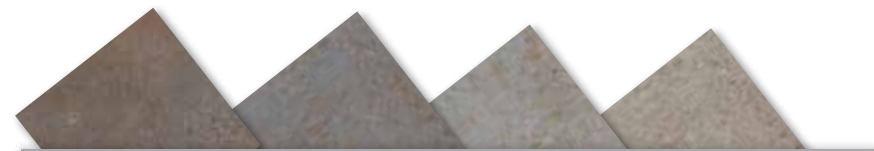

RokaCeram



DENIZ GRIS MARRON



DENIZ AZUL OSCURO



DENIZ AZUL CLARO



DENIZ GRAY

CARVING COLLECTION

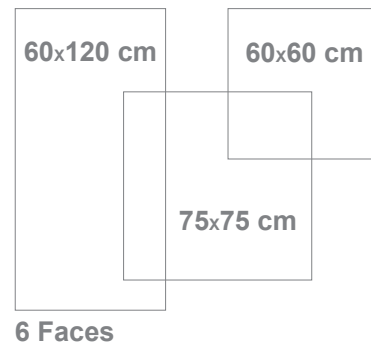

As the heart craves for the Autumn and its colors, one needs to step on Archipel and give their heart up to its orange, to its yellow and to its myride of awesome colors. A unique, stunning image.

 SPORT CENTER	 HEADQUARTER	 RESTAURANT	 HOTEL	 VENTILATED FACADES
 HOME	 SHOP	 HOSPITAL	 AIRPORT	 OFFICE
 FROST RESISTANCE	 RESIDENTIAL USE	 FLOOR TILES	 LIGHT COMMERCIAL	 WALL TILES



Thanks to its native 1.1cm thickness, provides lightness and strength in all applications - even the ones you'd never even imagined.



Rokaceram offers unmatched project flexibility and the freedom to give concrete form to your ideas without being shackled by size.



RokaCeram

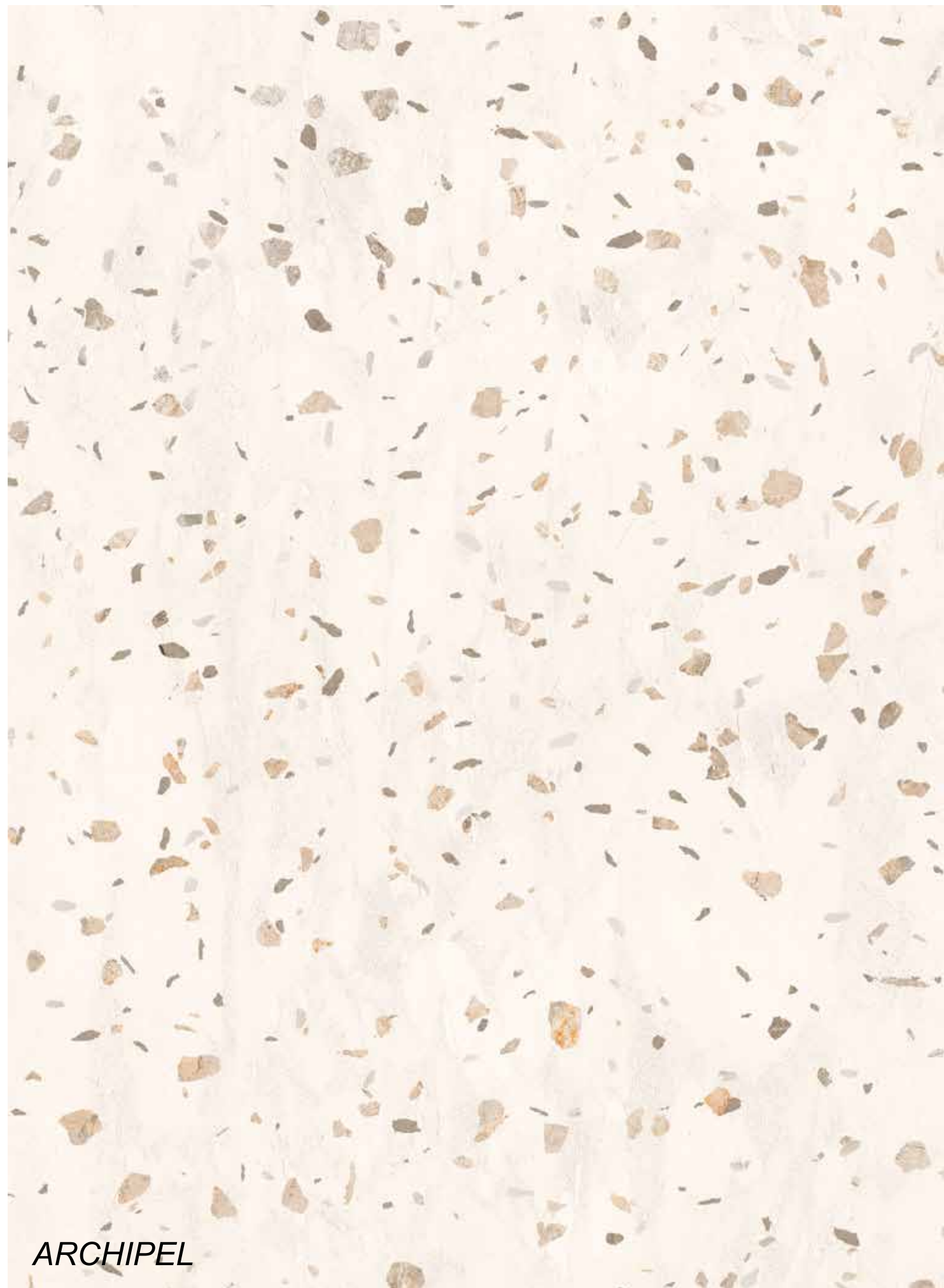

ARCHIPEL

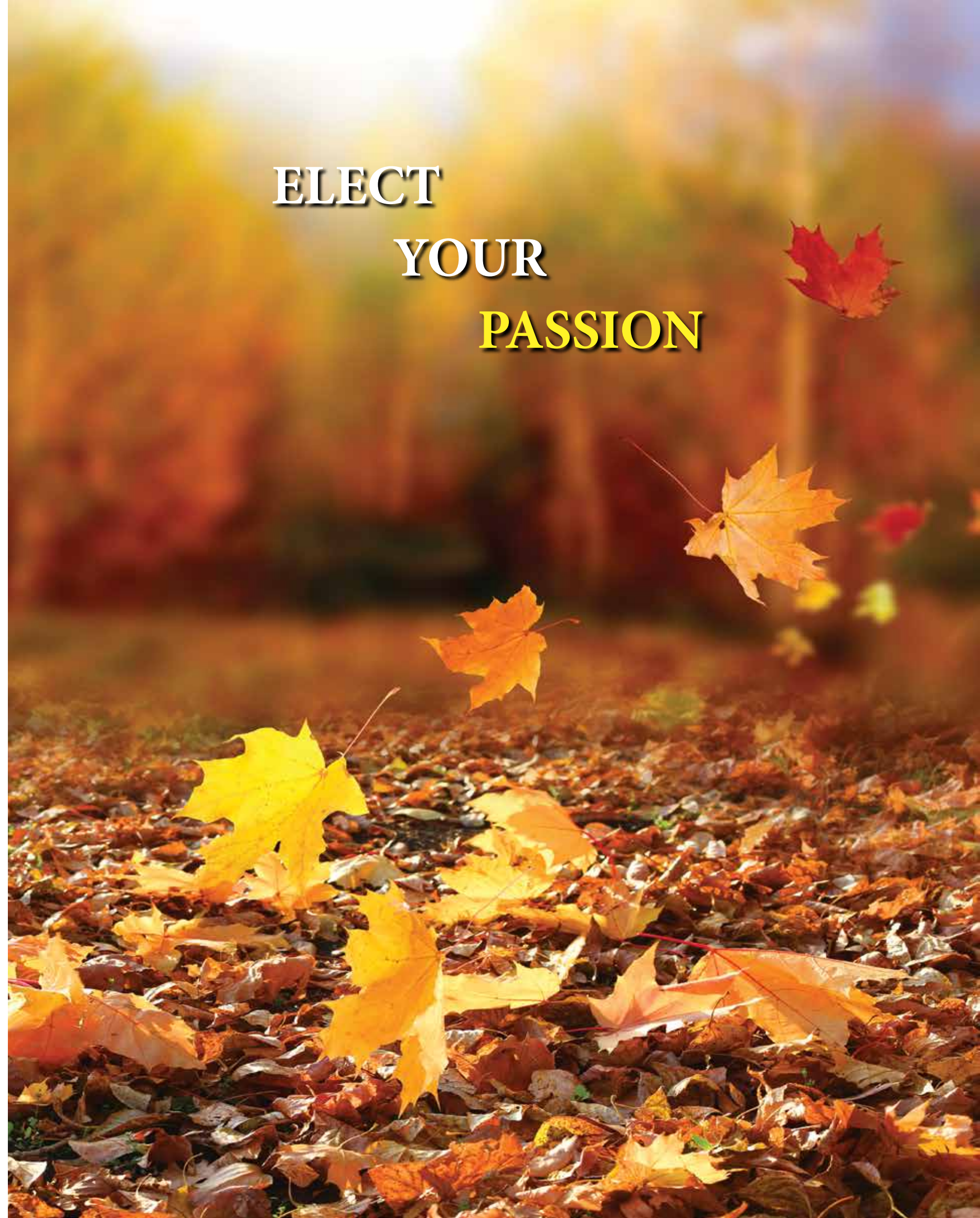

ELECT
YOUR
PASSION

CARVING COLLECTION

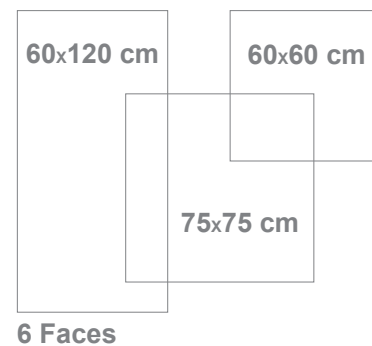

The aqua color, the superabundance, the parts all speak life and prosperity. The drops carry the sun inside and when moving, it throws light on the path. Merin is as elegant and tranquillizing as water.



Thanks to its native 1.1cm thickness, provides lightness and strength in all applications - even the ones you'd never even imagined.



Rokaceram offers unmatched project flexibility and the freedom to give concrete form to your ideas without being shackled by size.



RokaCeram

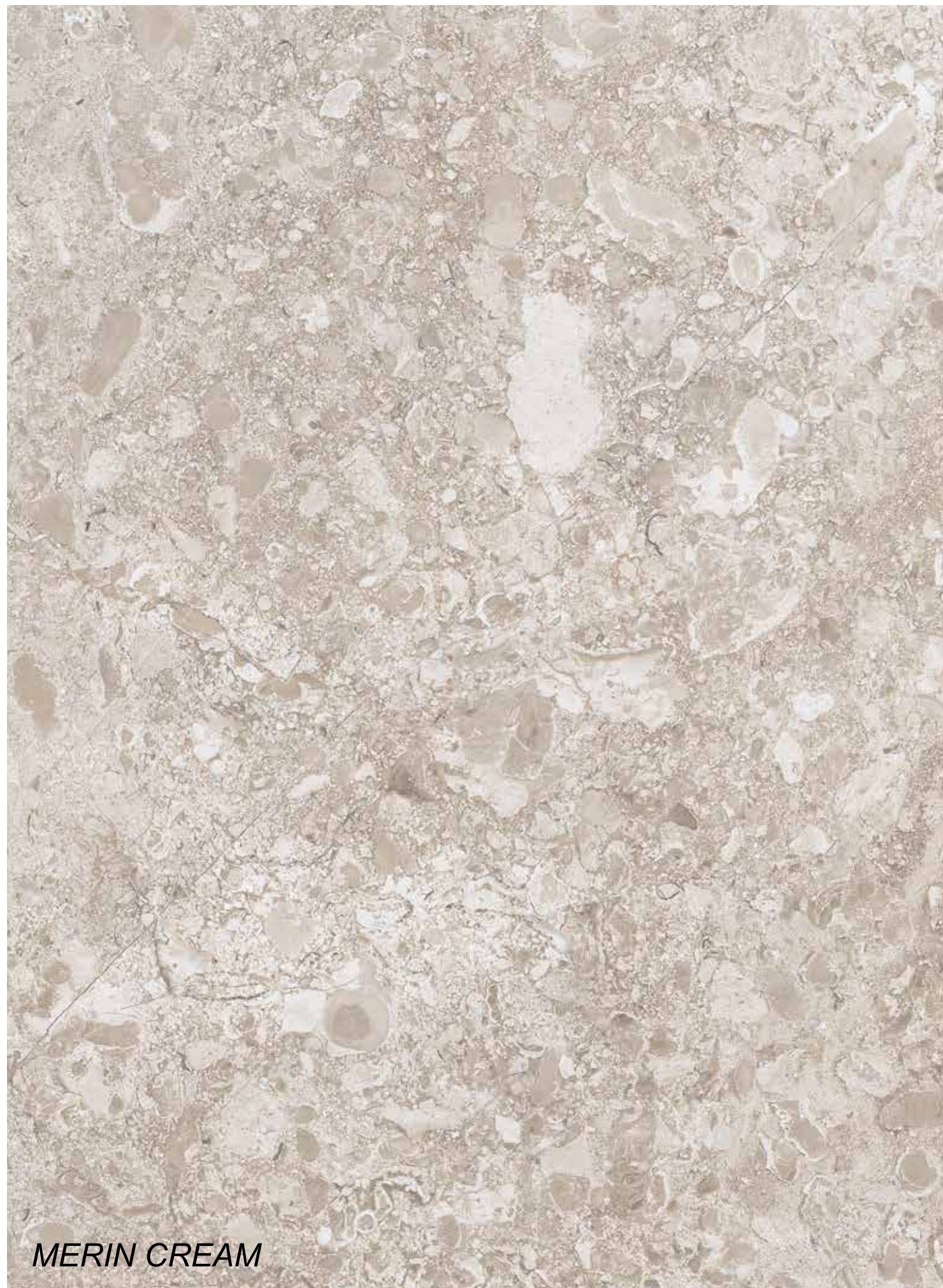

MERIN CREAM

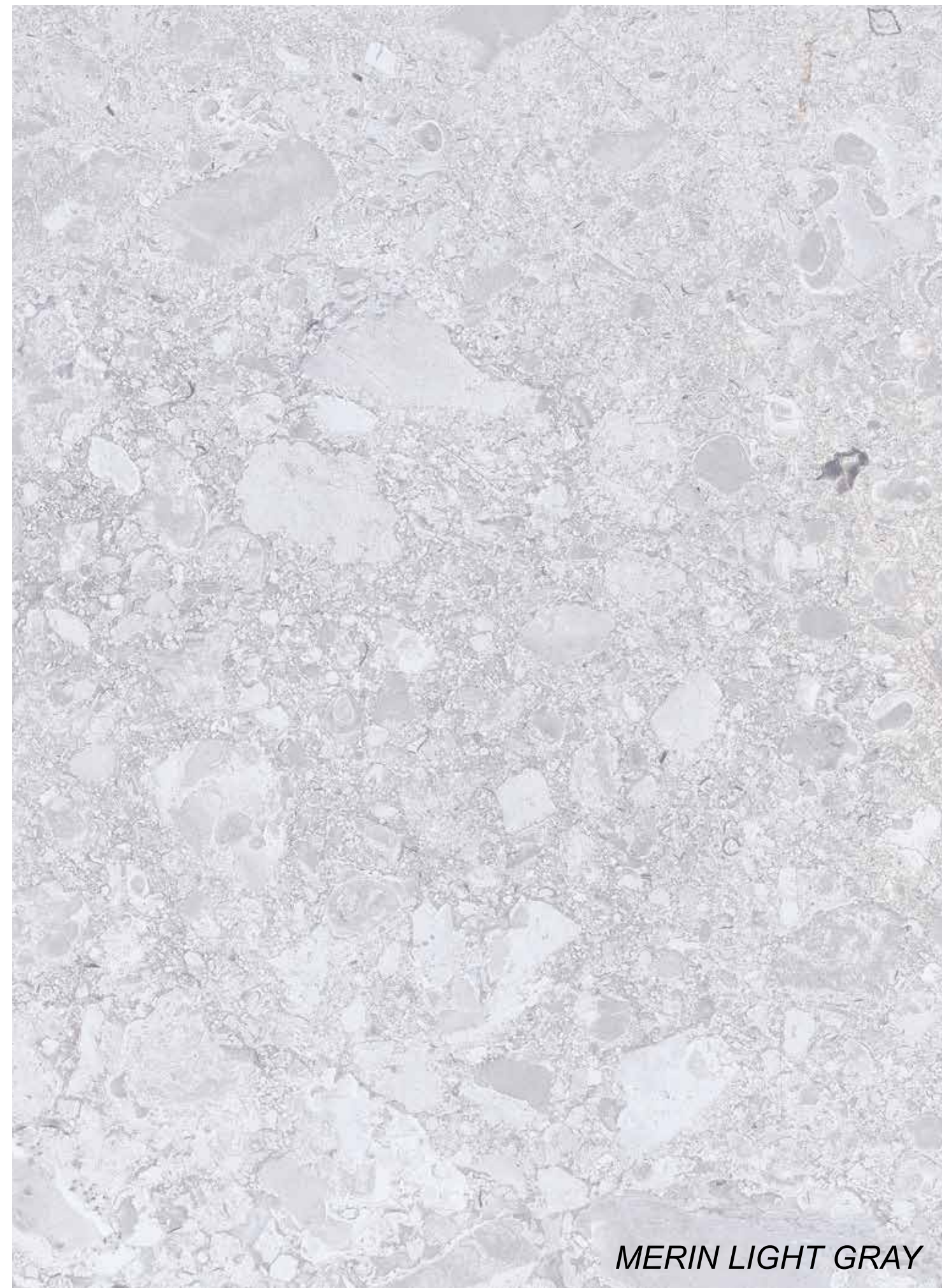

MERIN LIGHT GRAY



MERIN DARK GRAY

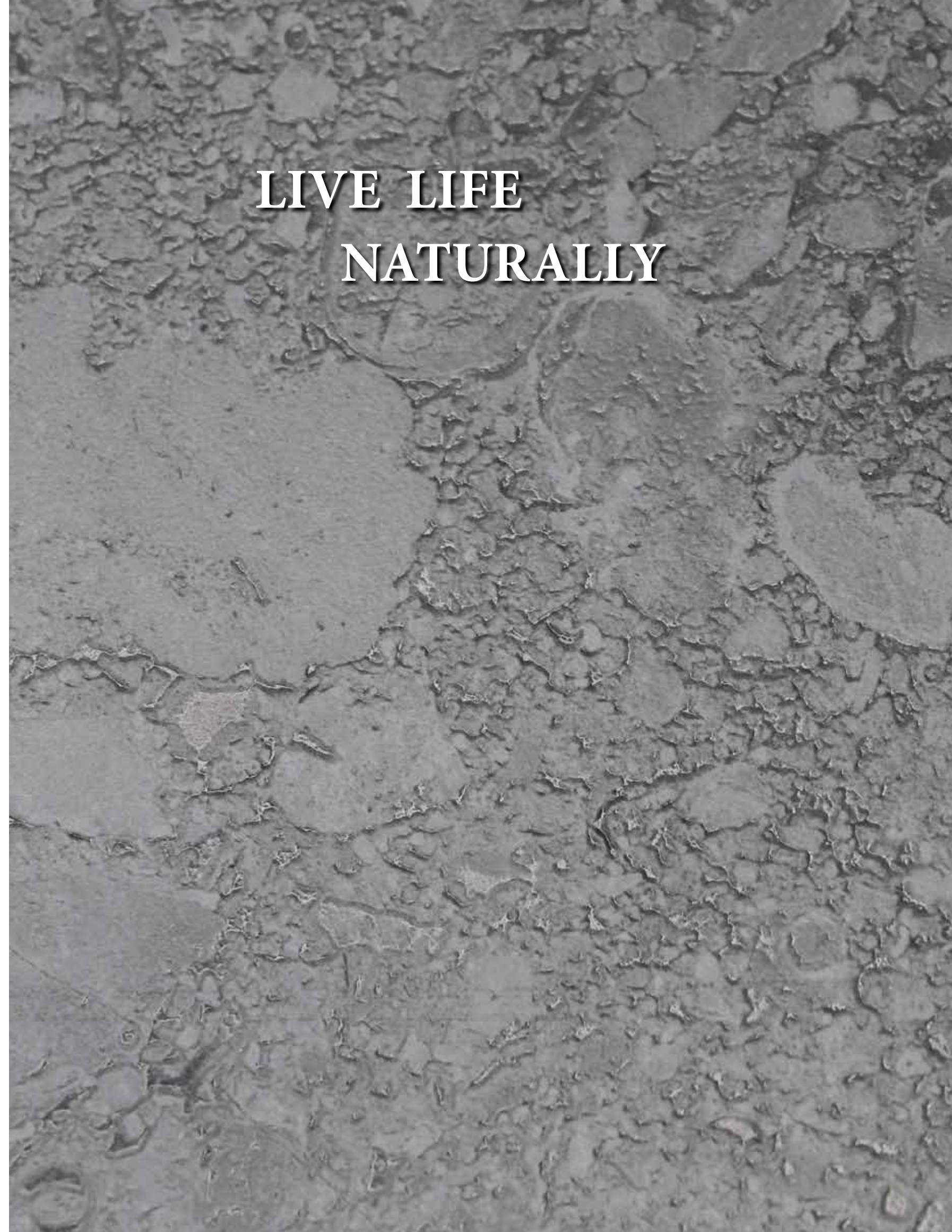

**LIVE LIFE
NATURALLY**

CARVING COLLECTION

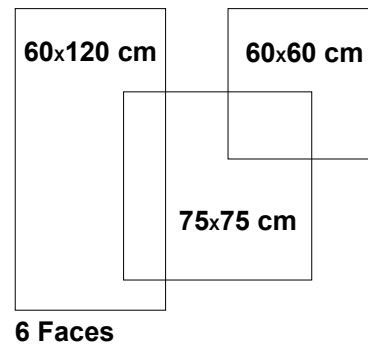

Royal is the center of light, reflects it and you'd enjoy the refraction on the surface. You'd see how capillaries of light open up the way and cover the whole surface.



Thanks to its native 1.1cm thickness, provides lightness and strength in all applications - even the ones you'd never even imagined.



Rokaceram offers unmatched project flexibility and the freedom to give concrete form to your ideas without being shackled by size.

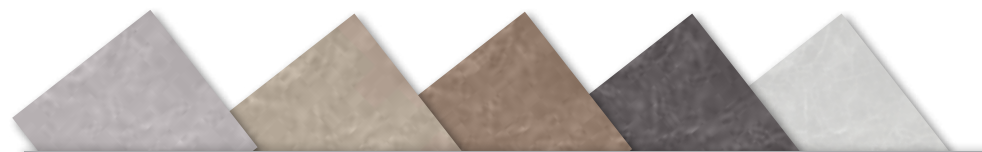

ROYAL DARK GRAY

RokaCeram



ROYAL LIGHT GRAY



ROYAL OLIVE



ROYAL CHOCOLATE

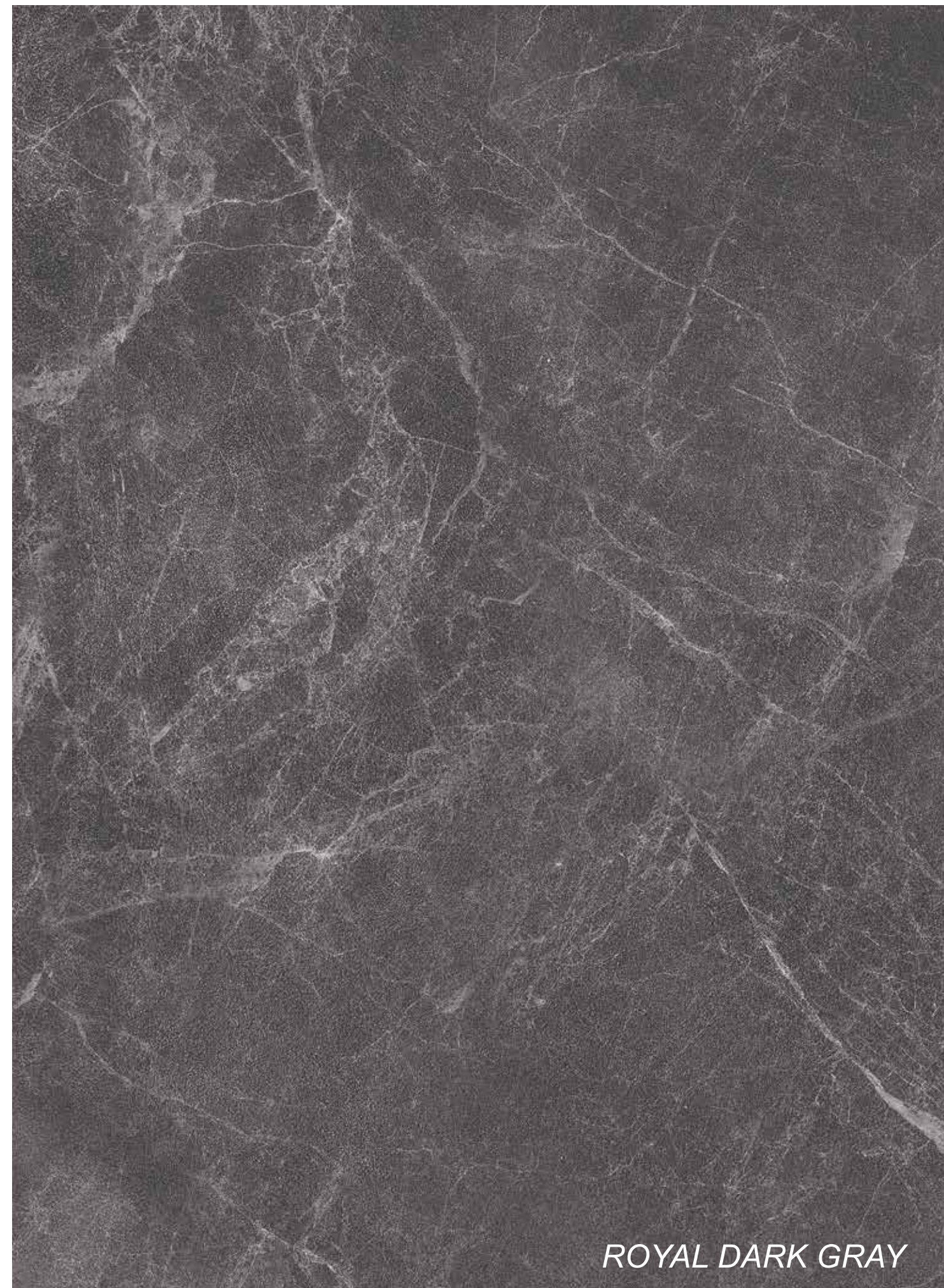

ROYAL DARK GRAY



ROYAL SILVER

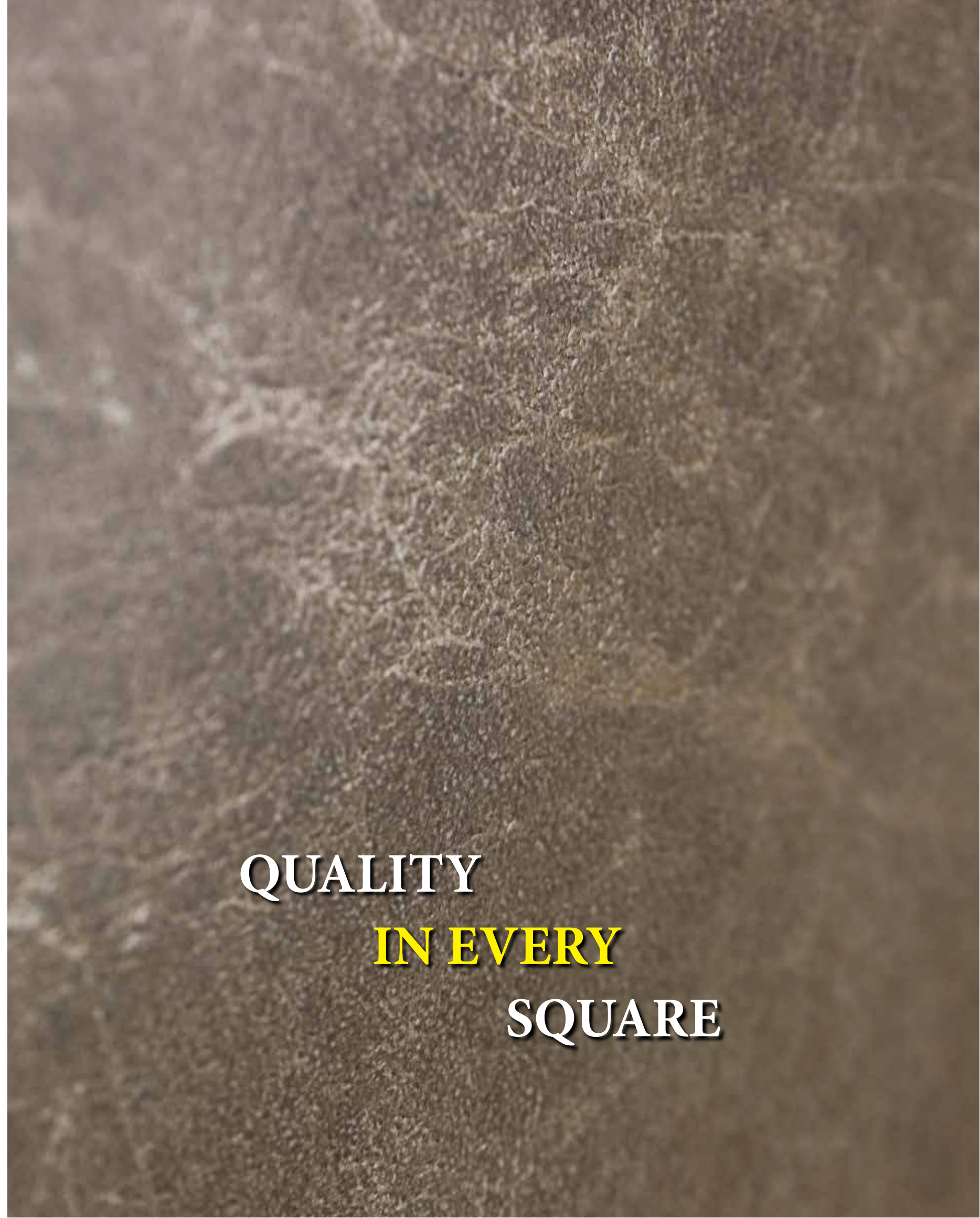

QUALITY
IN EVERY
SQUARE

CARVING COLLECTION

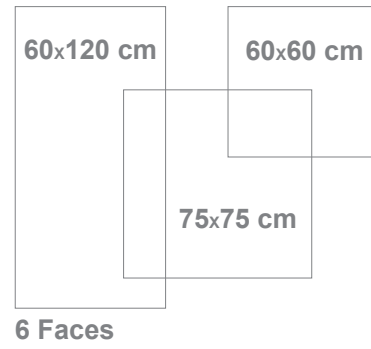

Remember your childhood, how simply you got happy with a kite, screaming and running. Arizona is a picture of this sweetness, joy and excitement.

 SPORT CENTER	 HEADQUARTER	 RESTAURANT	 HOTEL	 VENTILATED FACADES
 HOME	 SHOP	 HOSPITAL	 AIRPORT	 OFFICE
 FROST RESISTANCE	 RESIDENTIAL USE	 FLOOR TILES	 LIGHT COMMERCIAL	 WALL TILES



Thanks to its native 1.1cm thickness, provides lightness and strength in all applications - even the ones you'd never even imagined.



Rokaceram offers unmatched project flexibility and the freedom to give concrete form to your ideas without being shackled by size.

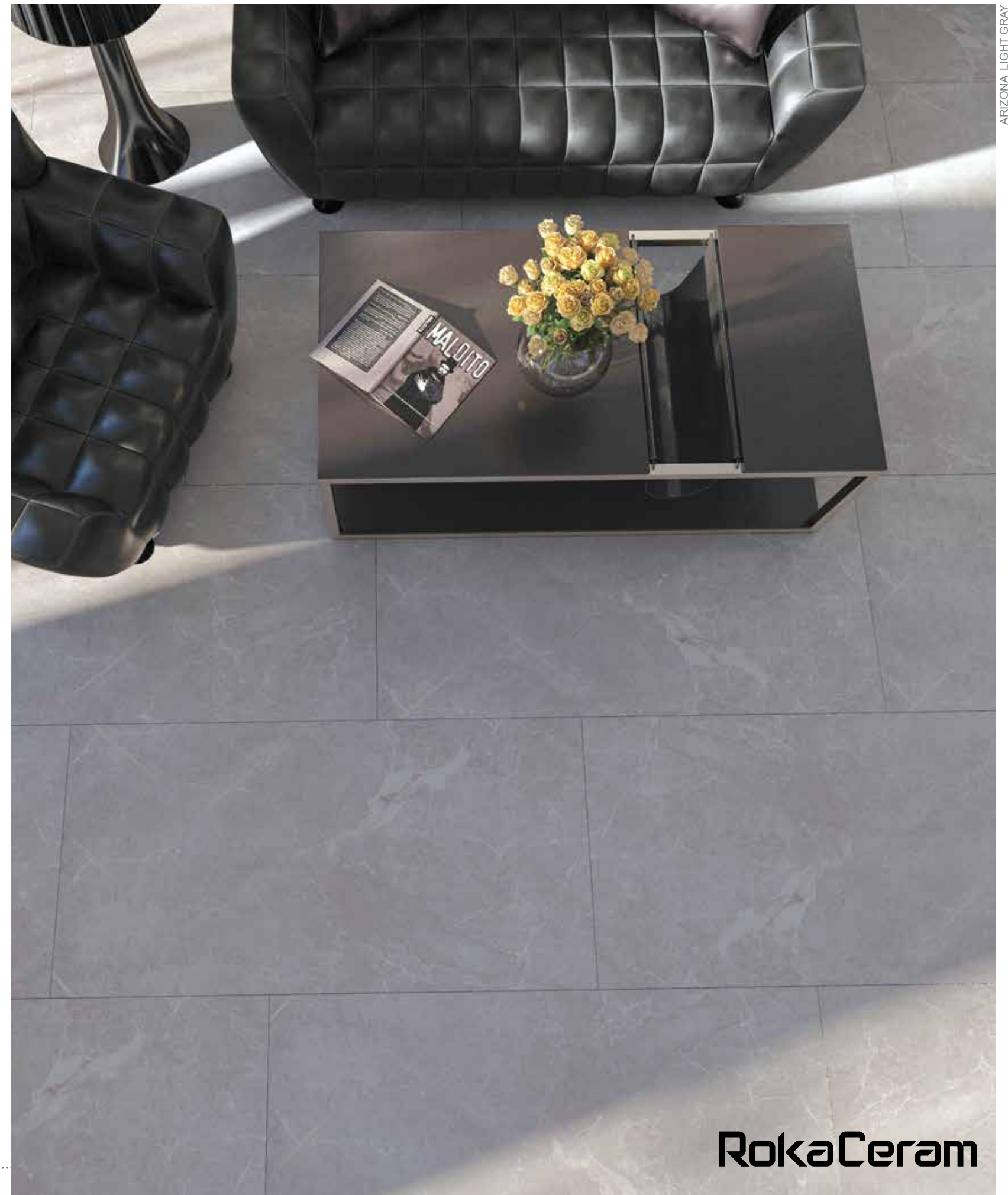

ARIZONA LIGHT GRAY

RokaCeram



ARIZONA DARK GRAY



ARIZONA LIGHT GRAY



ARIZONA OLIVE

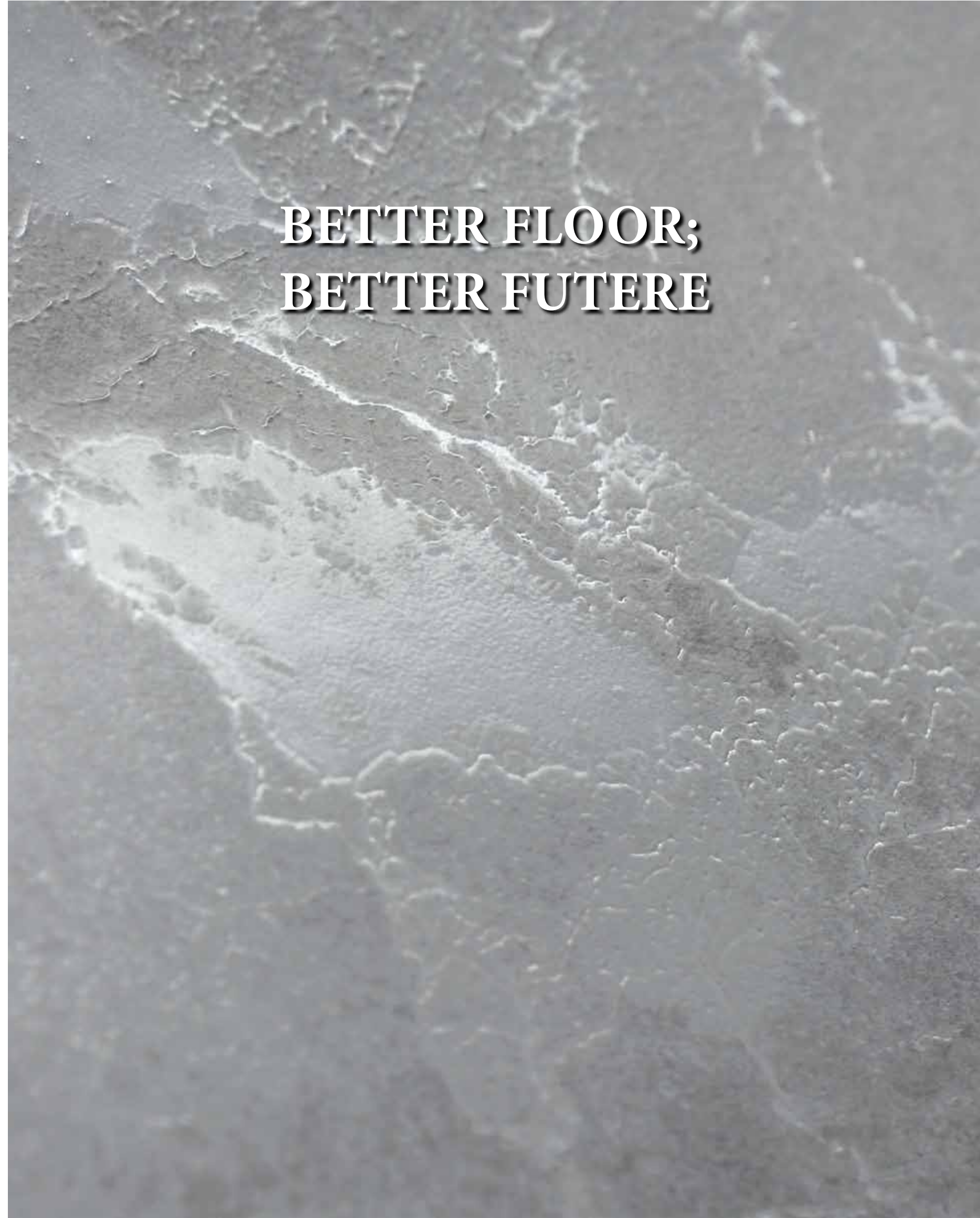

**BETTER FLOOR;
BETTER FUTERE**

CARVING COLLECTION

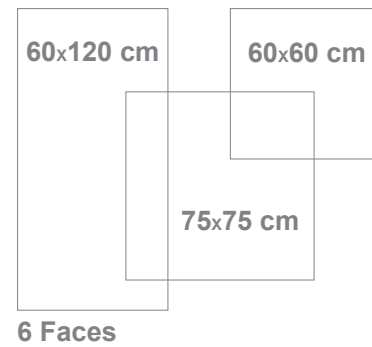

You stand behind the window and hold a brush. You paint on it and you balance its movements by your imagination and you drive yourself wherever it moves. This is the way Dyan should be looked upon.



Thanks to its native 1.1cm thickness, provides lightness and strength in all applications - even the ones you'd never even imagined.



Rokaceram offers unmatched project flexibility and the freedom to give concrete form to your ideas without being shackled by size.



RokaCeram



DYAN BEIGE CLARO



DYAN BEIGE OSCURO



WOOD, BE INSPIRED BY EFFECT TILES

ROKACERAM, the most ecological project.

The most ecological because it prevents trees from being felled. More resistant. It withstands solar radiation and wear and tear, undergoing no change in appearance, substantially improving on real wood's technical characteristics without relinquishing its beauty.

Safer. It is fire retardant, withstanding fire and stopping it from spreading. Thanks to its non-slip surface, it is also the perfect choice for wet areas and outdoor environments.

Better because the flooring repels water and conserves its formal structure, appearance and resistance.

ROKACERAM, genuine ceramic parquet flooring.

CARVING COLLECTION

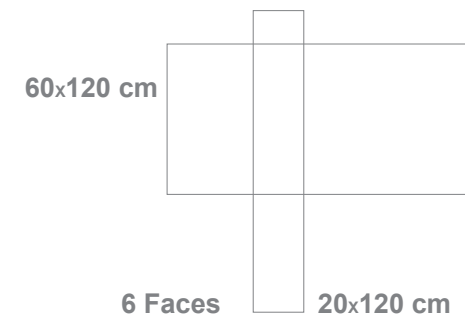

How beautiful is it if nature steps into your house without being damaged? You look at the lines of every tree, you see the fast pace of life, and you realize that life is as short as these lines. Let's not kill the time.



Thanks to its native 1.1cm thickness, provides lightness and strength in all applications - even the ones you'd never even imagined.



Rokaceram offers unmatched project flexibility and the freedom to give concrete form to your ideas without being shackled by size.

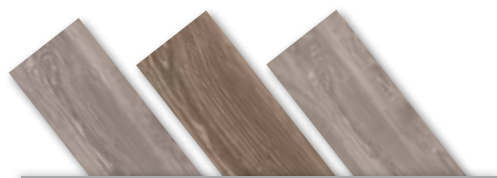

RokaCeram



VIENA GRIS



VIENA BROWN



FOR EVERY
WALKS OF LIFE

VIENA OLIVE

CARVING COLLECTION

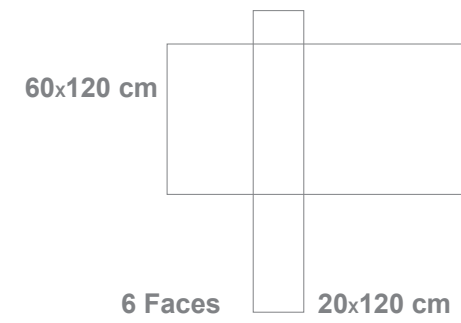

To those for whom tradition is a part of existence and seek decor in their own colors and in the color of a tree. Apply Canto to modern spaces rooted in tradition.



Thanks to its native 1.1cm thickness, provides lightness and strength in all applications - even the ones you'd never even imagined.



Rokaceram offers unmatched project flexibility and the freedom to give concrete form to your ideas without being shackled by size.

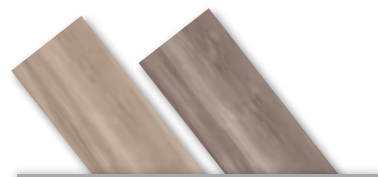



KANTO NESCAFE



KANTO BROWN

CARVING COLLECTION

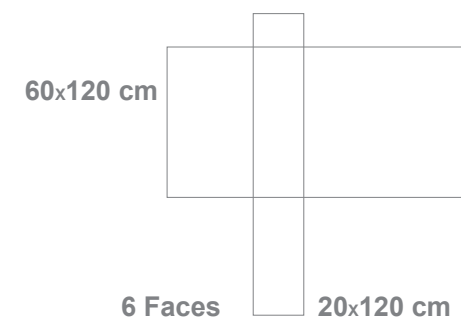

Wood is always the color of life, the color of nature; it robs your eyes' movement creating an image of idyllic alleys in your mind. If Lenna enters decor, it relives you from chaos.

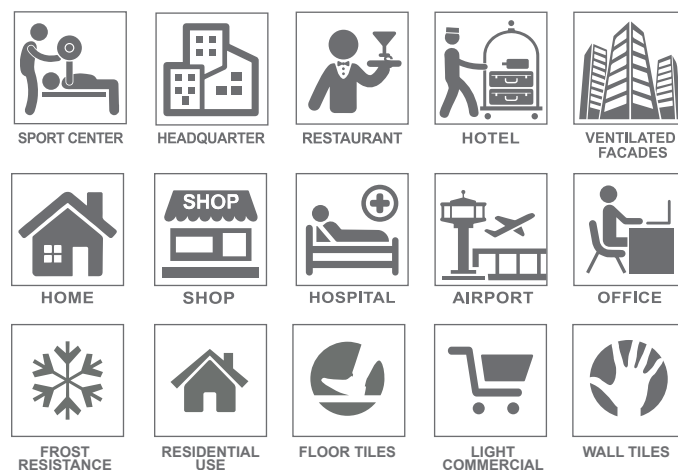

Thanks to its native 1.1cm thickness, provides lightness and strength in all applications - even the ones you'd never even imagined.



Rokaceram offers unmatched project flexibility and the freedom to give concrete form to your ideas without being shackled by size.

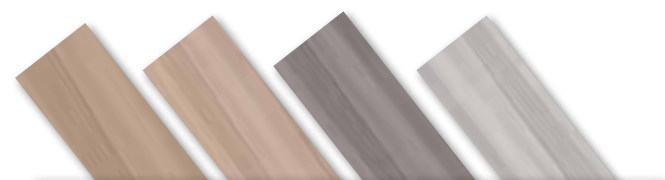

RokaCeram



LENNA CREAM



LENNA BROWN



LENNA DARK GRAY



LENNA LIGHT GRAY

CARVING COLLECTION

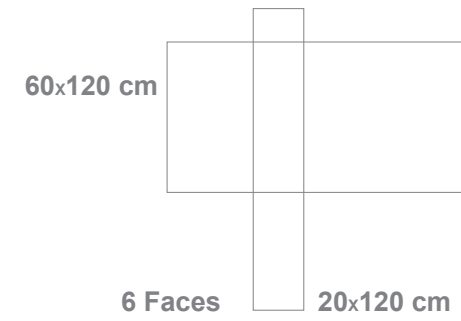

Bircola is a design of nature, of wood, but it is not solely the color. It is a design that is created by the opacity of the depth and obliges the viewer to come out of the opacity and enter light.



Thanks to its native 1.1cm thickness, provides lightness and strength in all applications - even the ones you'd never even imagined.



Rokaceram offers unmatched project flexibility and the freedom to give concrete form to your ideas without being shackled by size.



RokaCeram



BIRCOLA BEIGE



BIRCOLA ANTHRACITE



BIRCOLA BROWN



BIRCOLA DARK BROWN

CARVING COLLECTION

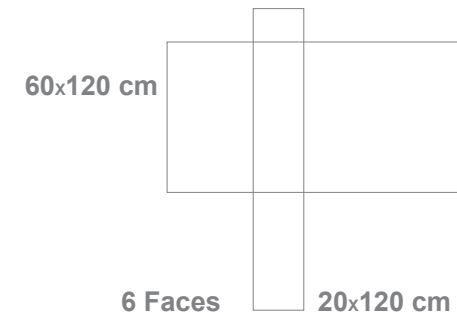

With Willer, you experience a fall, a curvature, a fall, and a curvature. This goes eternally on. In the meantime, you enter the vacuum and seconds of silence and stillness and then successive breaks of lines.



Thanks to its native 1.1cm thickness, provides lightness and strength in all applications - even the ones you'd never even imagined.



Rokaceram offers unmatched project flexibility and the freedom to give concrete form to your ideas without being shackled by size.

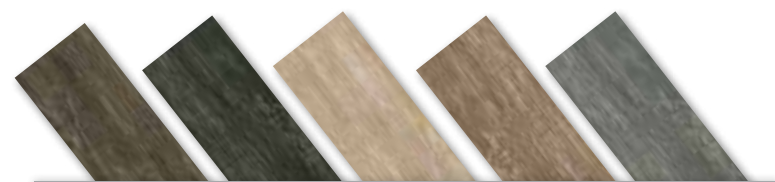



WILLER WARM GRAY



WILLER ANTHRACITE

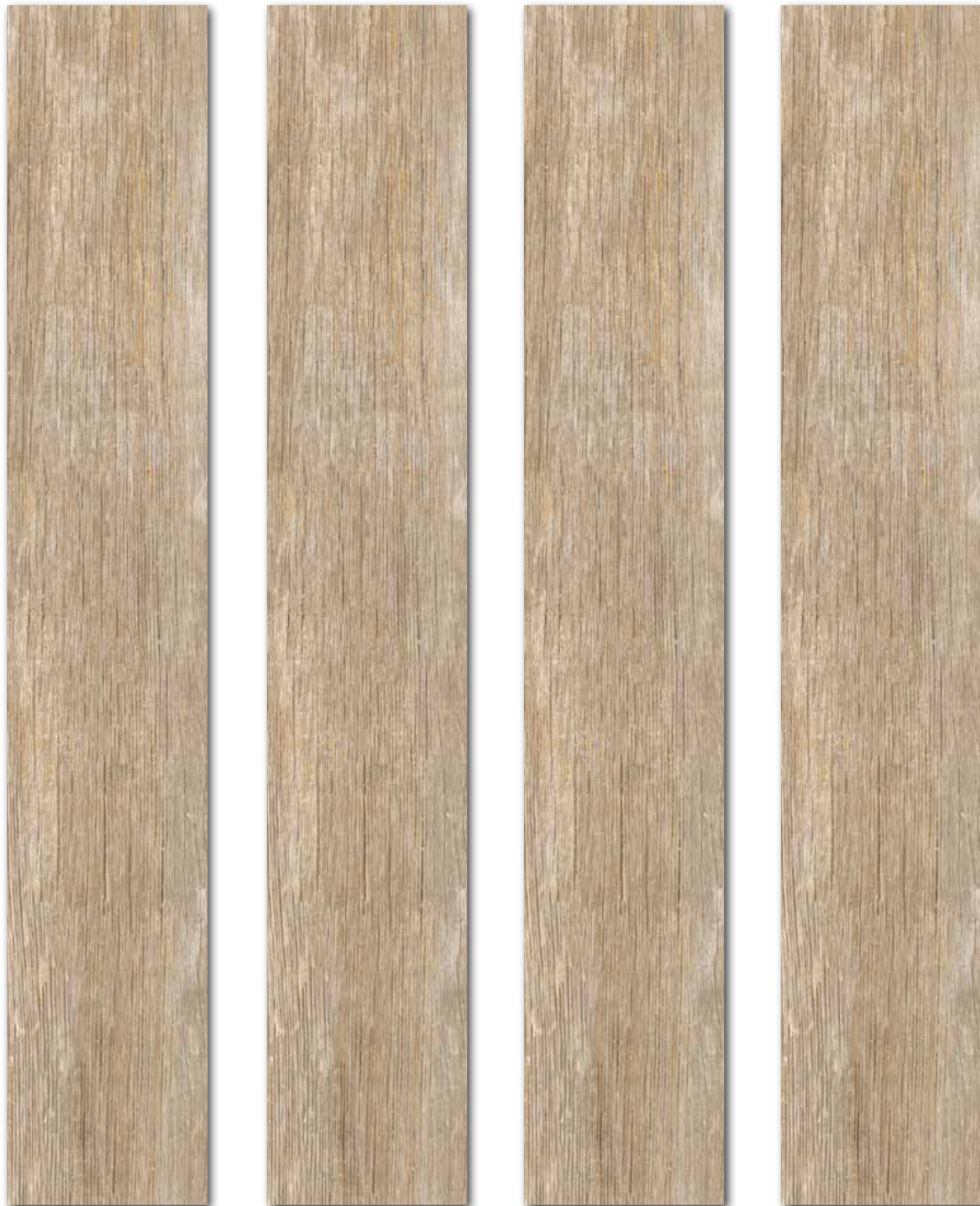

WILLER BEIGE



WILLER BROWN



OUR STANDARD
IS OUR QUALITY

WILLER COAL

Application guidelines

Types of tiles:

Wall ceramic tiles and decorative elements, glazed – water absorbance $E_b > 10\%$, Group BIII with parameters according to the standard EN 14411, Annex K. Tiles intended for indoor wall applications in *temperatures* above 0°C , tiles and decorative elements are not frost-resistant.

Floor ceramic tiles and decorative elements, glazed – water absorbance $0,5\% < E_b < 3\%$, Group BIb Frost-resistant manufactured with the use of the single firing technology, with parameters according to the standard EN 14411, Annex H. Tiles and decorative elements intended for indoor and outdoor applications.

Stoneware tiles and decorative elements porcellanato, glazed – water absorbance $E_b \leq 0,5\%$, Group BI a – Frost-resistant with parameters according to the standard EN 14411, Annex G. Tiles intended for indoor and outdoor wall and floor applications for residential and commercial areas. These tiles are characterized by low water absorbance, high resistance to bending, high hardness and wear resistance (according to the manufacturer's declaration on the packaging).

Ceramic tiles and decorative elements porcellanato, unglazed – water absorbance $E_b \leq 0,5\%$, Group BI a Frost-resistant with parameters according to the requirements of the standard EN 14411, Annex G. Tiles intended for indoor and outdoor wall and floor applications for residential and commercial areas, in the building entrance areas for interior and exterior stairs, and for building elevations.

Clinker tiles, Frost-resistant – water absorbance $0,5\% < E_b \leq 3\%$, Group BIb with parameters according to the standard EN 14411, Annex H. Tiles intended for applications in residential and commercial areas except those with heavy traffic, for interior and exterior stairs, terraces, hallways, building elevations, ledges, and fences. Clinker is characterized by high resistance to bending, low water absorbance, high weather resistance, which guarantees frost-resistance.

Technological characteristics of tiles. Tiles intended for floors should possess technical parameters and characteristics adequate for mechanical stress which they will be subjected to in a particular room. In case for glazed floor tiles, special parameter indicating the scope of their application should be taken into consideration namely wear resistance rating (PEI) and the number of revolutions.



Table of tiles use according to PEI wear resistance rating*	
Application:	Wear resistance category according to ISO 10545-7
Product should be used in all residential areas with light traffic, such as bathrooms, bedrooms, but not in kitchens or hallways. Tiles should be protected from scratching agents.	Wear resistance PEI 2 Number of revolutions – 600 Wear resistance PEI 3 Number of revolutions - 750
Product recommended for all residential areas with medium traffic, such as kitchens, bathrooms, except for areas with direct access from outside.	Wear resistance PEI 3 Number of revolutions - 1500
Dry-pressed ceramic tiles, intended for indoor and outdoor wall and floor applications for residential and commercial areas, and exterior elevation surface of the building. Product intended for light traffic areas, such as kitchens, bathroom, living rooms, except for floors with direct access form outside.	Wear resistance PEI 4 Number of revolutions - 2100
Product recommended for all medium traffic areas, such as residential and commercial areas. Tiles should be protected from scratching agents.	Wear resistance PEI 4 Number of revolutions - 2100
Product recommended for all relatively heavy traffic areas. If conditions do not allow for laying glazed tiles due to heavy traffic, it is recommended to use special product lines indented for that purpose. Tiles should be protected from scratching agents.	Wear resistance PEI 4 Number of revolutions – 6000 and above Wear resistance PEI 5 Number of revolutions – above 12000

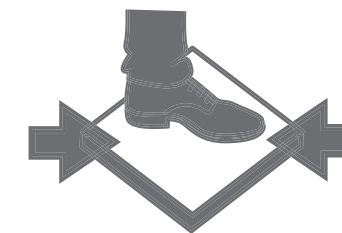

Anti-slip properties Anti-slip properties are determined based on the acceptable angle, i.e. the angle of inclination of the examined surface, which is used by the person performing the test and with which the limit of safe walking is reached. Due to anti-slip properties, tiles are divided into groups that determine the category of slip prevention. To mark anti-slip properties of floor tiles, symbols R9 to R13 are used, where the higher the R parameter, the less slippery the tile. Tiles with the acceptable angle value lower than 6° are not rated as anti-slip.

Tiles installation and jointing

Before work

- Tiles should be used according to their intended purpose
- Before installation, the entire purchased batch of the tiles should be verified with respect to their quality, hue, and caliber in order to make sure that no mistakes occurred when loading the product. To do that, tiles from different cartons should be compared. The buyer should verify if the marking of the caliber and hue on all the packages is the same. After the installation of the tiles, claims regarding those aspects shall not be considered.
- When selecting tiles with visible tonal differences, it is recommended to mix the products from different packages during the installation as those tonal differences are the intended effect.
- When installing the tiles, the instructions found in construction manuals and professional literature should be performed accordingly.
- Tiles installation should be performed by qualified workers.

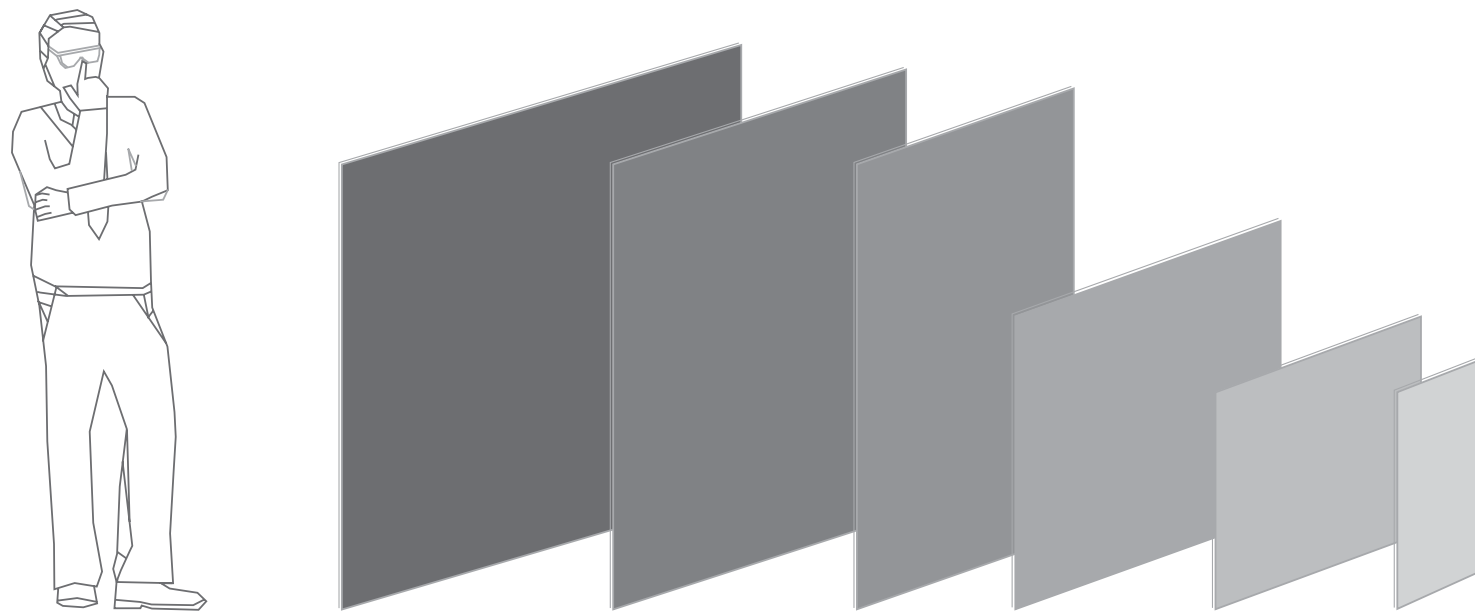

Base surface preparation

- Before beginning tile work, especially when floor heating is to be used, it is very important to visually assess the base surface. Base surface preparation should begin with its thorough cleaning. Floor level must be checked.
- If the surface where the tiles are to be installed is uneven, it must be leveled with a self-leveling mortar compound. If the surface is very uneven, the entire floor must be leveled.
- Next step is to prime the surface base. Priming liquid should be absorbed by the floor.
- Materials used for the preparation of the base surface with the floor heating should be used according to the manufacturer's instructions. Tile work should always be performed when the floor heating is switched off.

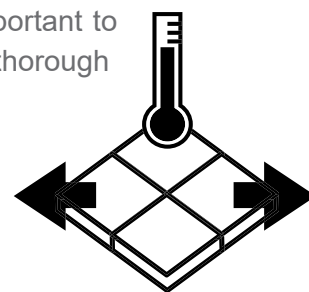

- When installing tiles on the surface with floor heating, it is important to remember to use appropriate surface spacing between independently operating heating areas. It is important due to the thermal expansion of materials. Taking into account temperature fluctuations, the floor should be divided every 9 – 16 m², if possible. The surface should be divided into square shaped areas as far as possible with the use of edge and peripheral spacing to divide the floor surface from wall surface. Expansion gaps in the layer of installed tiles should be consistent with already existing expansion joints in the surface.

Laying tiles

- Installation process should begin with planning, determination of the axis of the installation taking into account spacing, and making a simulation of the final effect by placing the tiles on the floor.
- Ceramic tiles have the right to have a small curvature, which is most frequently observed in long and narrow products. To level any possible differences that may arise during the installation, the tiles should be installed with the maximum offset to the 1/3 of the length of the neighboring tile. This shall allow to reach the intended effect and shall ensure an even floor surface.
- After the planning phase, tiles should be collected and installed on an evenly spread adhesive mortar.
- For large format tiles, it is recommended to use tile leveling systems which significantly improve the visual aspect of the floor as well as allow to level any imperfections resulting from the surface irregularities, tile work shortcomings, or tile curvature.
- The glue should be prepared according to the manufacturer's instructions taking into special account the amount of mixing water, time in which the mortar maintains adequate adhesion, and the fixture time.
- Glue mortar should be spread evenly on the previously prepared base surface. The mortar layer's thickness should comply with the glue manufacturer's instructions. Mortar should be applied with the use of a notched trowel where the notch size is adjusted to the size of the tiles.
- Tiles should be placed and pressed into the applied glue and then slightly moved on the surface to ensure their proper adhesion.
- Tiles should always be glued with the entire surface. Ceramic tiling should form a permanent whole with the surface base (when lightly knocked on, it should not produce a hollow sound).

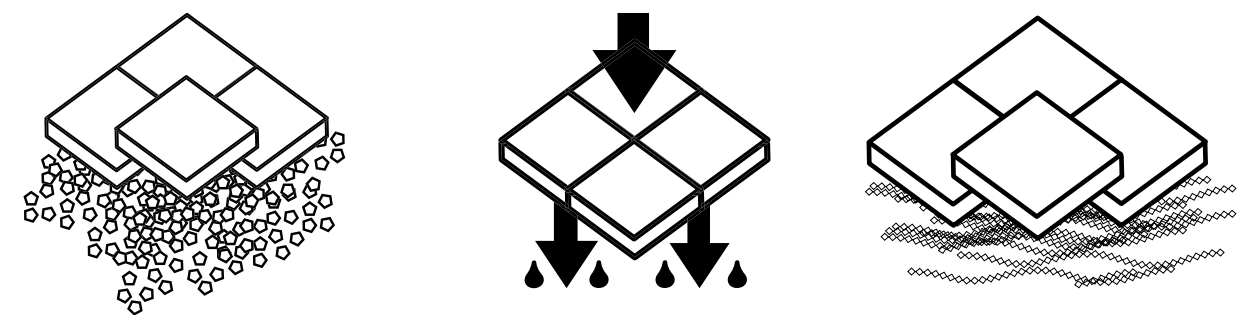
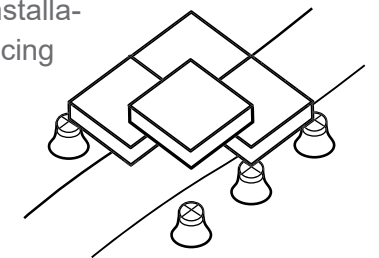

Jointing tiles

- Tiles should always be installed with a joint as tiles laid jointlessly shall form a very compact whole which shall be sensitive to any type of stress. The principal purpose of the joint is to level the stress caused by temperature fluctuations or surface deformations.
- Jointing tiles should be started after verifying that the tiles are completely stuck to the surface base (in the time indicated by the glue's manufacturer).
- When grouting tiles, particularly glass elements with the use of epoxy joints, the time needed for the mixing water to evaporate from the mixed materials should be taken into consideration. If the jointing is performed too soon, the humidity remaining under the material may cause discoloration of glass elements.
- In order to achieve the desired appearance of the ceramic tile work, jointing must be performed according to the grouting instructions found on the joint packaging. Special attention must be paid to the amount of mixing water, fixture time, and the time after which the grout excess must be removed.

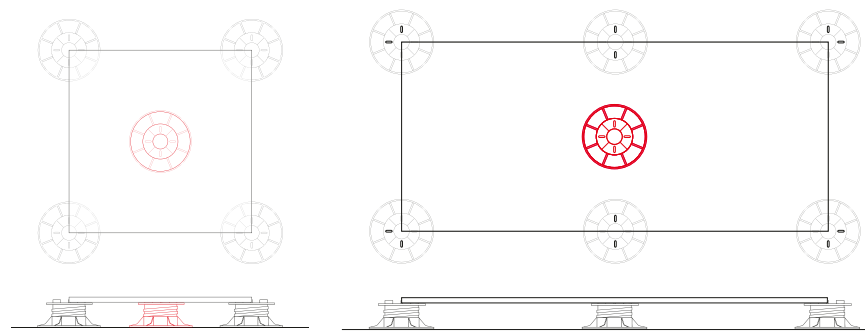

- Before jointing the entire ceramic tile work, it is recommended to test the grout on a small fragment (tile fragment) and perform a control cleaning in order to determine the effect of the joint on the type of the tiles used.
- The prepared mixture should be spread with the use of a rubber trowel. Tiles should be jointed in parts measuring no more than 3 - 4 m². Where horizontal and vertical surfaces meet as well as in places where tiles touch sanitary devices or jambs, elastic material sealing such as, for example, silicone must be used. To avoid making the tiles dirty, the edges may be covered with masking tape. Then, joint is applied. Before the mixture hardens, the tape must be removed.



- For jointing decorative elements, no coarse-grained joint should be used. The metallic surface of ceramic decorative elements is susceptible to scratching, which is why it is recommended to use acrylic, silicone, or other fine-grained (soft) grouts.
- When jointing with the use of the coarse-grained grout, the decorative element surface must be protected with masking tape, for example.
- Cleaning of the jointed surface should be performed according to the mortar manufacturer's instructions. Joint excess should be gently removed from the tile surface making sure fresh joint is not washed off and the surface does not get scratched.
- Impurities on glazed and unglazed tiles caused by different kinds of mortars should be removed with the use of appropriate cleaning agents available on the market and then washed off with water.

Linings use and maintenance

- The time after which the installed ceramic tile surface can be used depends on the parameters of the applied glue. Glue manufacturer determines the time after which it reaches its maximum endurance.
- Glazed wall and floor tiles should be washed with cleaning products available on the market and intended for this type of surfaces.
- Regular stoneware tiles care requires cleaning products specifically intended for this type of surfaces, in accordance with the instructions attached to the product.
- Lappato type tiles care requires only products with neutral pH, i.e. 6.5 to 7.5.
- Tiles and decorative elements should not be cleaned with aggressive or coarse-grained liquids or other materials that can damage the surface.
- Chemical agents should be diluted according to the manufacturer's instructions.
- Everyday washing and removal of greasy impurities should be performed with the use of alkaline agents which do not contain gloss polishes that would leave a thin film on the surface.
- To remove tartar from the evaporated water used for everyday washing or removal of impurities left after a careless assembly, acidic products, such as construction chemicals, should be used periodically.
- It is important to remember that snow or ice from the surface of the tiles must not be removed with a sharp tool as the tiles may get easily damaged.

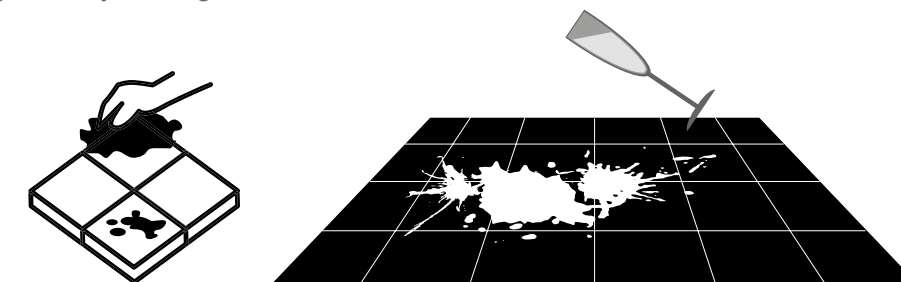

Simple foodstuffs (coca-cola, wine, water etc.) can remove the bright patina. The original surface is more matt.

ROKACERAM FLOOR AND WALL TILE ADHESIVE DESCRIPTION

ROKACERAM FLOOR AND WALL TILE ADHESIVE is a water-resistant floor & wall adhesive, suitable for thin and thick-bed fixing in interiors and exteriors. Mixed with water, it is suitable for fixing ceramic floor and wall tiles, vitrified tiles and mosaics, quarry tiles, brick slips and stone claddings. **ROKACERAM FLOOR AND WALL TILE ADHESIVE** is frost and water-resistant and can be used in showers, swimming pools or under continuous immersion. This product is available in 10kg and 20kg.

PREPARATION

The surface to be tiled should be level, clean and free from dust, grease or any loose flaking material.

Suitable surfaces include: Brickwork/concrete, Plaster, Plasterboard, Asphalt (suitable grade e.g. flooring)

APPLICATION

1. Spread the adhesive with a suitable notched trowel to cover approximately 1 m² or 15-20 minutes working time.
2. For floor tiling, wet areas and exterior situations, a solid-bed trowel must be used.
3. Press the dry tiles firmly into the adhesive, checking periodically that good contact is maintained with the backs of the tiles. Tiles should be fixed within 20-30 minutes of adhesive being applied, depending on the surface porosity and atmospheric conditions (check the adhesive ribs periodically and if a skin has formed, remove the residue and apply a new layer). Tiles can be adjusted up to 5-10 minutes after initial positioning.
4. Leave 1-2mm joints between wall tiles and minimum 3mm joints between floor tiles unless self-spacing tiles are being used.
5. Remove all surplus adhesive with a damp cloth before it sets.

NOTE **ROKACERAM FLOOR AND WALL TILE ADHESIVE** is fully resistant to water, however, being cement based it is not impervious to the passage of water. To improve protection on water-sensitive backgrounds, apply a waterproofing membrane such as **ROKACERAM SHOWER WATERPROOFING KIT** and / or an impervious grout.

GROUTING Allow a minimum of 24 hours before grouting or longer if the background is of low absorption.



STORAGE & SHELF LIFE

This product must be stored in unopened packaging, clear of the ground in cool dry conditions and protected from excessive draught. If stored correctly this product has a shelf life of 6 months.

COVERAGE

Depends on the nature and flatness of the surface and the method of application, but on a level background the amount of adhesive required at 3mm thickness will be: approx. 2kg/m² for dry wall areas. Approx. 3.5kg/m² for floors, exterior and wet areas. Please refer to the Material Safety Data Sheet for further information on health and safety issues.



TECHNICAL CHART

Specifications	Size			
	75*75 cm	60*60 cm	60*120 cm	20*120 cm
Thickness (mm)	11.5±0.1	11±0.1	11±0.1	11±0.1
Weight of each Tile (kg)	13.5±0.5	8.5±0.5	17.5±0.5	5.5±0.5
Tile per Carton (pcs)	3	4	2	5
Weight of Carton (kg)	42±2	35±2	36±2	28±2
Dimensions Size (cm)	75*75	60*60	60*120	20*120
Cartons per Pallet (pcs)	40	36	60	54
S.M per Carton (m ²)	1.69	1.44	1.44	1.2
S.M per Pallet (m ²)	67.6	51.8	86.4	64.8
Dimensions of Pallet (cm ²)	110*125	105*105	105*105	110*125

TECHNICAL SPECIFICATIONS

Properties	Europe Standard	COO Standard		ROKA Standard	
	ISO 13006	Standard	Test Method		
Physical	Water Absorption	Eb<0.5%	Eb<0.5%	INSO 9169-3	Eb<0.5%
	Modulus of Rupture and Breaking Strength (Flexi)	35 N/mm ²	35 N/mm ²	INSO 9169-4	40 N/mm ²
	Frost Resistance	Must Be Mached	Must Be Mached	INSO 9169-12	OK
	Crazing Resistance For Glazed Tiles (Autoclave)	Must Be Mached	Must Be Mached	INSO 9169-12	OK
	Resistance to Surface Abrasion for Glazed Tiles	-	The Abrasive Category Should be Mentioned	INSO 9169-6	2
	Chemical	Resistance to Stains	Min 3	Min 3	INSO 6200
Chemical Resistance of Glazed Tile		Min GB	Min GB	ISO10545-13	GB
Resistance Of Acid & Base (weak)		Must Be Mached	Must Be Mached	ISO10545-13	GLB
Dimensions And Surface	Dimensions	±0.6%	±0.6%	INSO 9169-2	±0.05%
	Thickness	±5%	±5%	INSO 9169-2	± 3%
	Parallelism Sides	±0.5%	±1.5mm ± 0.5mm	INSO 9169-2	± 0.3% (1mm)
	Surface Flatness	±0.5%	±0.5mm ± 2mm	INSO 9169-2	± 0.5% (1.5mm)
	Orthogonality	±0.5%	±0.5mm ± 2mm	INSO 9169-2	± 0.3% (1.5mm)



CERTIFICATE

QUALITY MANAGEMENT SYSTEM

This is to certify that
Roka Ceram Co.
Roka Ceram Company, 5 km, Eastern Belt, Meybod, Yazd

has been assessed and found in compliance with the requirements of
QMS ISO 9001:2015
For the following scope:
Manufacturer of Tile and Ceramic

BRS LLC has the right of ownership of this certification; therefore it is NOT transferrable and remains the property of BRS LLC.
Original Registration Date: 1 Mar 2020
Issue Date: 2 Mar 2020
Expiry Date: 2 Mar 2023
Certificate with code: QMS2012002S03-00

Further clarifications on the scope of this certification and the applicability of ISO 9001 for the purpose to regulatory obligations may be obtained through communication with BRS LLC. This registration is included in the BRS LLC Directory of Registered Organizations and applies within the scope shown above. By issuance of this certification, the organization will update and maintain its registration in accordance with current revisions of current ISO 9001 through annual surveillance and regulatory purposes to the points of origin and commercialization.

O.M.Sam, BRS LLC Managing Director
Bultek Registration Services LLC
The certificate is issued at technical office: No. 308, Akhond Towse, Eshkezar St., Marandeh Blvd., Tehran, IRAN
Head office: 11/4/B Argjehi St., Kezron 0015, Yerevan, Armenia
BRS LLC operates according to the BRS ROWO (Rancho Springs, California, USA) principles & policies

SZUTEST

CERTIFICATE OF COMPLIANCE

Reference Number of Licence:	S/2007601
Date of First Issue of Licence:	16/03/2020
Licence Valid Until:	16/03/2023
Name of the Licence Holder:	Roka Ceram Yazd Co.
Address of the Licence Holder:	No. 16, 12 th Alley, Sarafraz Str. Beheshti Ave. Tehran/Iran
Manufacturer:	Roka Ceram Yazd Co.
Manufacturing Address:	5 th km-Eastern Ring way of Meybod-Yazd, Iran
Registered Trade Mark:	ROKA & PATTERN
Related Standard:	EN 14411 Ceramic tiles – Definition, classification, characteristics, assessment and verification of constancy of performance and marking
Scope of Licence:	Dry-pressed ceramic tiles, with water absorption E ₃ ≤0.5%
Related Declaration of Performance:	DOP-01
Related Directive:	Regulation (EU) No: 305/2011 – Construction Products

Szutest has observed that Declaration of Performance is in accordance with relevant initial information mentioned above which were submitted by the manufacturer. Szutest confirms presence of Factory Documentation. This certificate is not derived from Attestation and Verification of Constancy of Performance (EU) No 305/2011 - Construction products and does not remove responsibilities of the manufacturer as defined in Article 1.5 of Annex

B. Karami, ELAVC
Head of Construction Products Department

SZUTEST UYGUNLUK DEĞERLENDİRME A.Ş.
Tic. Sic. No: 271147, Şişli, No: 1, Dışkapı, 34174 İTİHARU, TÜRKİYE
Szutest.com.tr

CUSTOMER SATISFACTION
Guidelines for complaints handling in organizations

This is to certify that
Roka Ceram Co.
Roka Ceram Company, 5 km, Eastern Belt, Meybod, Yazd

has been assessed and found in compliance with the requirements of
ISO 10002:2018
For the following scope:
Manufacturer of Tile and Ceramic

BRS LLC has the right of ownership of this approval; therefore it is NOT transferrable and remains the property of BRS LLC.
Original Registration Date: 1 Mar 2020
Issue Date: 2 Mar 2020
Expiry Date: 2 Mar 2023
certificate with code: CHO2003202S03-00

Further clarifications on the scope of this certificate and the applicability of ISO 10002 for the purpose to customer satisfaction may be obtained through communication with BRS LLC. The registration is included in the BRS LLC Directory of Registered Organizations and applies within the scope shown above. By issuance of this certificate, the organization will update and maintain its registration in accordance with current revisions of current ISO 10002 through annual surveillance and regulatory purposes to the points of origin and commercialization.

O.M.Sam, BRS LLC Managing Director
Bultek Registration Services LLC
The certificate is issued at technical office: No. 308, Akhond Towse, Eshkezar St., Marandeh Blvd., Tehran, IRAN
Head office: 11/4/B Argjehi St., Kezron 0015, Yerevan, Armenia
BRS LLC operates according to the BRS ROWO (Rancho Springs, California, USA) principles & policies

This electronic certificate can be authenticated by contacting BRS LLC. By issuance of this certificate the organization will update and maintain its registration in accordance to current regulations through the application of the current version of ISO 10002.
For more information about this document, please contact to technical.dept@bresglobal.com

OCCUPATIONAL HEALTH AND SAFETY
MANAGEMENT SYSTEM

This is to certify that
Roka Ceram Co.
Roka Ceram Company, 5 km, Eastern Belt, Meybod, Yazd

has been assessed and found in compliance with the requirements of
OHSMS ISO 45001:2018
For the following scope:
Manufacturer of Tile and Ceramic

BRS LLC has the right of ownership of this certification; therefore it is NOT transferrable and remains the property of BRS LLC.
Original Registration Date: 1 Mar 2020
Issue Date: 2 Mar 2020
Expiry Date: 2 Mar 2023
Certificate with code: OHSMS2003002S03-00

Further clarifications on the scope of this certificate and the applicability of ISO 45001 for the purpose to safety considerations & regulatory obligations may be obtained through communication with BRS LLC. The registration is included in the BRS LLC Directory of Registered Organizations and applies within the scope shown above. By issuance of this certificate, the organization will update and maintain its registration in accordance with current revisions of current ISO 45001 through annual surveillance and regulatory purposes especially labor law to the points of origin and commercialization.

O.M.Sam, BRS LLC Managing Director
Bultek Registration Services LLC
The certificate is issued at technical office: No. 308, Akhond Towse, Eshkezar St., Marandeh Blvd., Tehran, IRAN
Head office: 11/4/B Argjehi St., Kezron 0015, Yerevan, Armenia
BRS LLC operates according to the BRS ROWO (Rancho Springs, California, USA) principles & policies

This electronic certificate can be authenticated by contacting BRS LLC. By issuance of this certificate the organization will update and maintain its registration in accordance to current regulations through the application of the current version of ISO 45001.
For more information about this document, please contact to technical.dept@bresglobal.com

ENVIRONMENTAL MANAGEMENT SYSTEM

This is to certify that
Roka Ceram Co.
Roka Ceram Company, 5 km, Eastern Belt, Meybod, Yazd

Has been assessed and found in compliance with the requirements of
EMS ISO 14001:2015
For the following scope:
Manufacturer of Tile and Ceramic

BRS LLC has the right of ownership of this approval; therefore it is NOT transferrable and remains the property of BRS LLC.
Original Registration Date: 1 Mar 2020
Issue Date: 2 Mar 2020
Expiry Date: 2 Mar 2023
certificate with code: EMS2003102S03-00

Further clarifications on the scope of this certificate and the applicability of ISO 14001 for the purpose to environmental considerations & regulatory obligations may be obtained through communication with BRS LLC. The registration is included in the BRS LLC Directory of Registered Organizations and applies within the scope shown above. By issuance of this certificate, the organization will update and maintain its registration in accordance with current revisions of current ISO 14001 through annual surveillance and regulatory purposes especially environmental regulation to the points of origin and commercialization.

O.M.Sam, BRS LLC Managing Director
Bultek Registration Services LLC
The certificate is issued at technical office: No. 308, Akhond Towse, Eshkezar St., Marandeh Blvd., Tehran, IRAN
Head office: 11/4/B Argjehi St., Kezron 0015, Yerevan, Armenia
BRS LLC operates according to the BRS ROWO (Rancho Springs, California, USA) principles & policies

This electronic certificate can be authenticated by contacting BRS LLC. By issuance of this certificate the organization will update and maintain its registration in accordance to current regulations through the application of the current version of ISO 14001.
For more information about this document, please contact to technical.dept@bresglobal.com



ADORN YOUR DREAM...

**ARCHITECTURE
AROUND THE WORLD**

HOTELS, RESTAURANTS, STORES.
CAR DEALERS, OFFICES, PUBLIC SPACES,
FACADES CLINICS, EXTERIORS, RESIDENTIAL



DESIGNED & DEVELOPED BY ROKACERAM
Dubai Office: Roka General Trading LLC (RokaCeram)
Marrakech St-Umm Ramool - Dubai - UAE.
Tel: +971 (4) 338 7473, Email: info@rokaceram.ae



RokaCeram Group^{sl}
Spain Licensed

PORCELAIN TILE CATALOGUE

www.rokaceram.ae / info@rokaceram.ae



RokaCeram